

Contents	Page
Introduction	2
Key Changes in the 2018 16 LSR	4
Supporting Guidance	5
Minimum Mandatory Health & Safety Framework	13
 <u>Contractor Safety</u>	
1. Contractor Safety Management	18
 <u>Machinery Safety</u>	
2. Machinery Safety	23
3. Energy Isolation / LOTOTO or LOTO	30
4. Electrical Safety	37
 <u>Transport</u>	
5. Site Transport	40
i. Rail Operations	
ii. Occupational Road Safety	
6. Forklift Safety	51
7. Mobile Phones	54
8. The Management of Contract Transport (Heavy Goods Vehicles on the Public Roads)	62
 <u>Project / Design Safety</u>	
9. Construction Project Safety	68
10. Road Surfacing / Repair operations	70
 <u>Work at Height / Falling Objects</u>	
11. Lifting Operations	73
12. Work at Height	79
i. Protecting against falling objects	
ii. Work near water	
 <u>Specific High Risk Activities</u>	
13. Work in Confined Space	96
14. Lone/Remote working	100
15. Explosive Safety	102
16. Process Safety / Occupational Health / Housekeeping	104
i. Prevention of contact with hot material, gases and surfaces	
ii. Prevention of Fire & Explosions	
- Including the prevention of overpressurisation in vessels	
iii. Process: Change management	
iv. Storage, handling and process use of hazardous substances	



2017 has been another successful year for CRH Group and across Europe in a number of aspects, with continued growth and improved business performance across many of our operations; a sincere thank you for your part in this strong delivery. However, in the area of Safety, our top priority at CRH, it has regrettably been a very challenging and disappointing year.

In 2017 we had 13 fatal accidents across CRH; 13 people who did not return home to their families and friends at the end of a normal working day. The fatal accidents were a combination of public road accidents involving our contractors, people fatally injured while working on our sites, and third parties impacted by our operations. This is clearly unacceptable. All of us, at all levels across the organisation, need to look hard at ourselves and how we manage safety, and in particular the critical (fatal) risks within our areas of responsibility.

One of the most disappointing elements to these fatal accidents is that the causes and circumstances behind each one was not new – they were hazards that were already well known in our business. We must therefore face up and confront the fact that, despite some excellent work done in each business and each team, we are not **consistently** applying the lessons learnt and the requirements of the 16 Life Saving Rules at each site, every day and for every task.

We want to remind all levels of management, in a constructive way, and those in site supervisory positions that you have the primary responsibility for safety within your areas of control. With this responsibility comes accountability. There are many tools that are available to support our businesses in managing safety risks, but it is the consistent day-to-day implementation of critical risk controls, as highlighted in the 16 Life Saving Rules, that is the key to delivery on our target of zero fatalities and zero serious accidents.

Contractors, along with third parties, accounted for 10 of the 13 fatal accidents across CRH in 2017. We continue to face a significant challenge across our 1,400 locations in Europe to ensure that contractors, which represent a significant proportion of the workforce on our sites, are properly qualified and have clear expectations on how they behave while working for CRH. It is all of our responsibility, no matter what we do, to ensure that contractors are behaving safely when working for CRH.

The **2018 version of the 16 Life Saving Rules** incorporate new details and images around recent accidents in our Industry. It also includes some new requirements (see page 4) and represents an ongoing effort to improve risk control measures and to continuously drive our safety standards forward. These rules are **mandatory** across CRH and must be implemented in full, for all of our employees and our contractors.

We must continue to maintain the strongest possible daily focus on the management of safety, and ensure that we are relentless in our implementation of the **16 Life Saving Rules**. In a focused, simple way the 16 LSR ensure that we direct our attention to those areas with the greatest potential for serious injury.

To repeat the closing message from our introduction to the 2017 16 LSR – *“Our management of safety is a direct reflection of our overall management of our company. We expect you to provide the leadership and visible commitment to the various elements of our safety program.”*

We look forward to working **together** with you to achieve zero fatalities and zero serious accidents in 2018.

Ken McKnight,
President,
CRH Europe Heavyside

David Dillon,
President,
Europe Lightside & Distribution



The **16 Life Saving Rules** are designed to give clear, specific requirements which will ensure consistency across our operations in the management of critical risks. These rules are mandatory and non negotiable and are a key part of our strategy to learn from past accidents and prevent repeat incidents.

The 16 LSR are supported by example based guidance documentation (see pages 5 to 8 of this document) and have been developed following wide ranging consultation at all levels within the division.

The 2018 version includes some additional requirements (see summary table on page 4) .

The implementation of the 16 Life Saving Rules is supported by the following:

- A program of independent 16 Life Saving Rule audits , which are carried out with minimum notice throughout the year and across all companies.
- Senior Management safety workshops .
- A program of monthly Safety Alerts and Best Practice Examples which relate to specific areas of the 16 LSR – these monthly communications are designed to keep energy in the safety message and provide fresh ongoing accident / incident material for safety engagement structures.
- A dedicated safety campaign is run each year ,led by the Country/Platform Managers which will focus on key elements within the 16 LSR.

The CRH Minimum Mandatory Framework for Health & Safety Management is also contained in this document (see pages 13 to 16) and covers the minimum requirements for a safety management system that must be in place.

The HSE team look forward to working with you all to ensure the on-going development and implementation of the **16 Life Saving Rules**.



Michael Keating
HSE Director
CRH Europe
January 2018

Key Changes in the 2018 16 LSR

Page	Addition/Change	Comment
13	Points 1 and 4	Amended
14	Points 5 and 9	Amended
15	Points 10, 11, 12, 14	Amended
16	Points 17, 18, 19, 20	Amended
17	Point 21	Added
20	Requirement 2 (part of)	
20	New requirements 3,4,5	In practice this points are already covered in the Contractor Safety Checklist
26	Requirements 9 and 10	These are the requirements for prestart warning alarms as previously communicated
30/31	New requirements 6 and 9	Supported by guidance photos
37	New requirement 6	Supported by guidance photos
41	Requirement 2 (part of)	
41	Requirement 4 (part of)	New ISO standard
42	Requirement 8 (part of)	New reduced mileage limit
43	Requirement 11, 12, 13	
51	Requirement 7	
55-61	Mobile Phones	A whole new section / requirements
63	Requirement 7	
73	Requirement 2 (part of)	
73	Requirement 5 (part of)	
74	Requirement 13	
81	Requirement 11 (part of)	
81	Requirement 13	
82	Requirement 16 (part of)	
82	Requirement 17	
82	Requirement 18	
97	Requirement 6	
112	Requirement 6 (part of)	

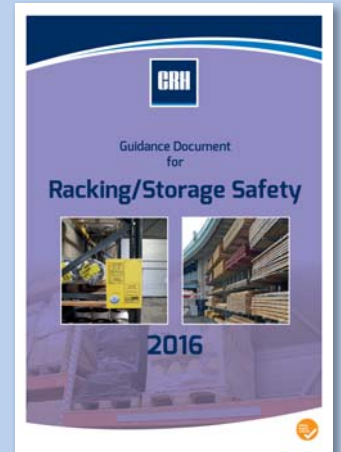
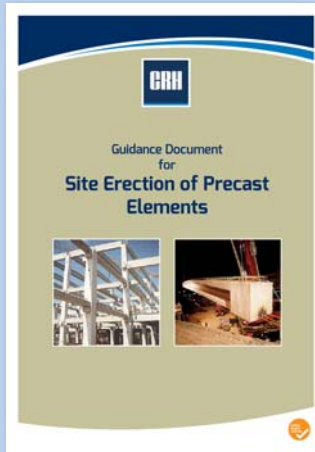
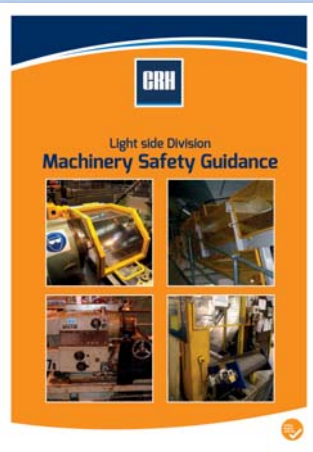
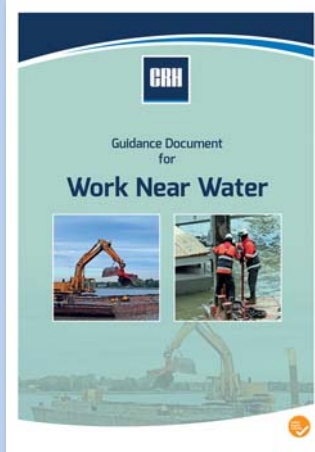
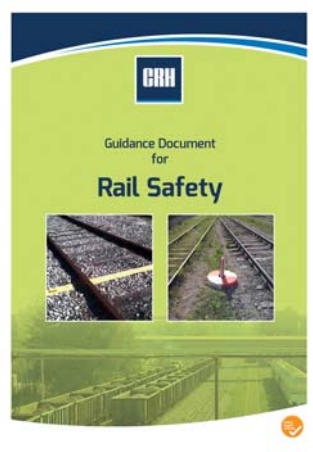

To be developed in 2018

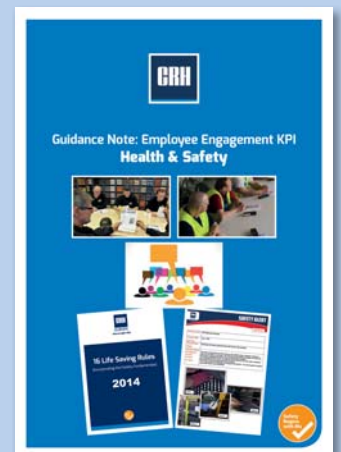
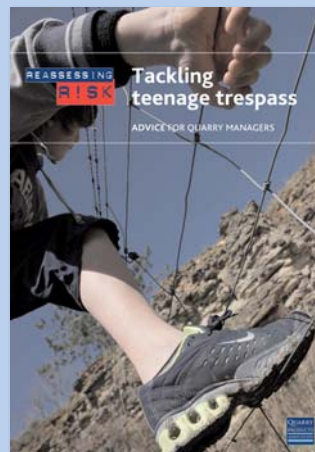
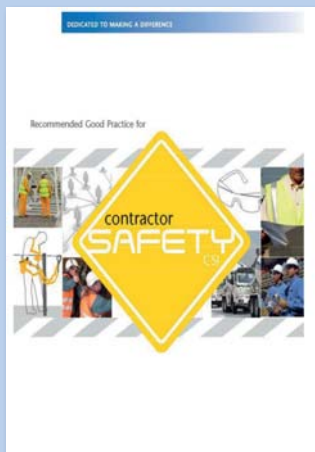

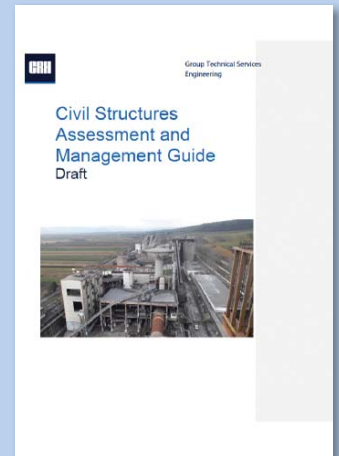
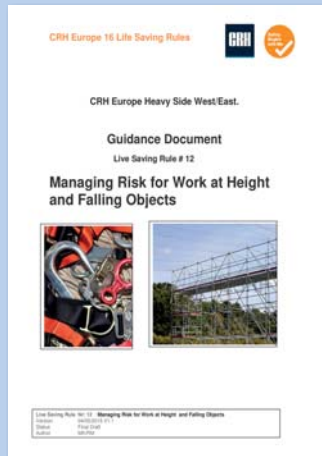
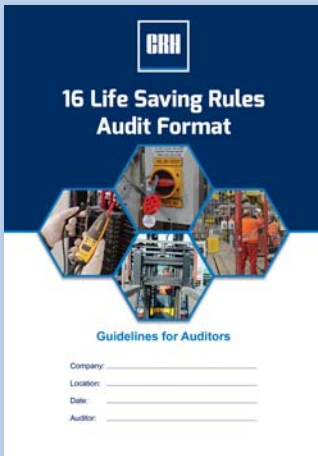
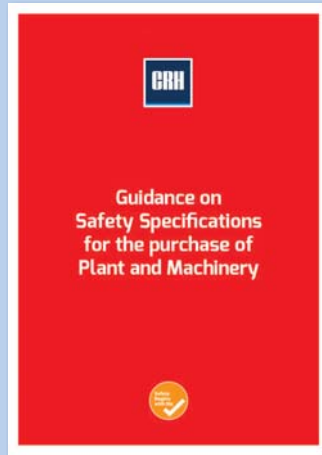

To be issued in 2018

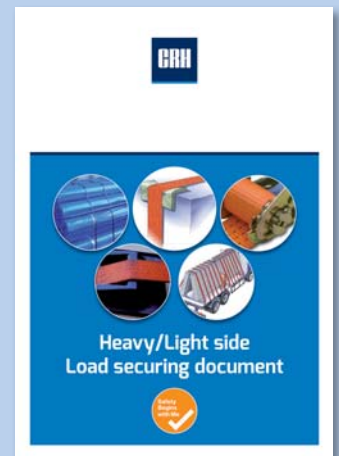
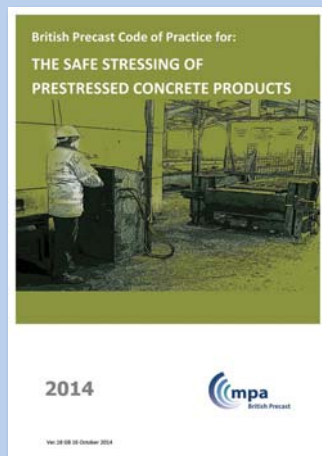
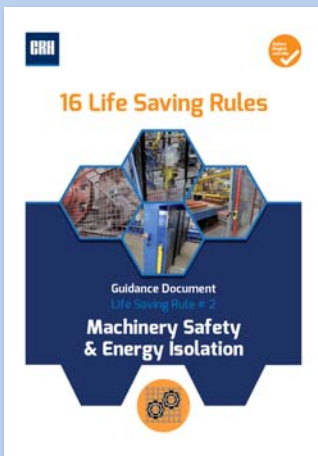

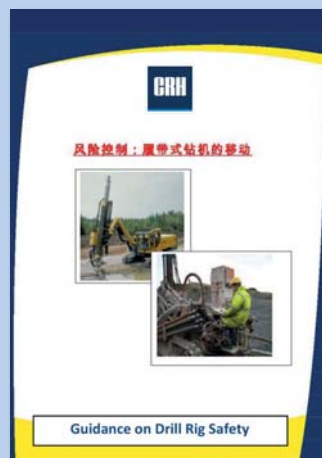
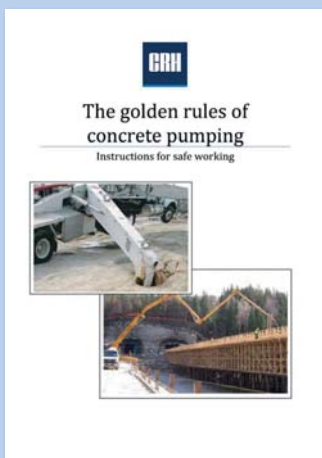
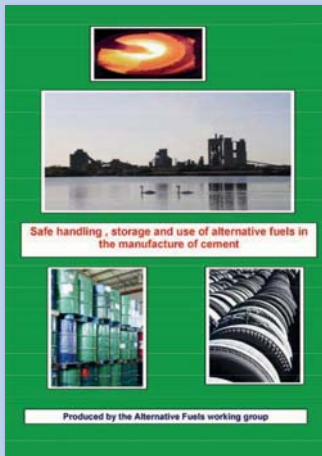
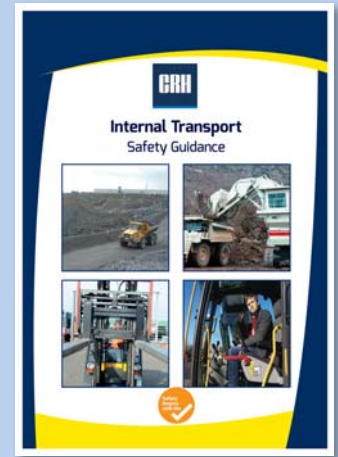
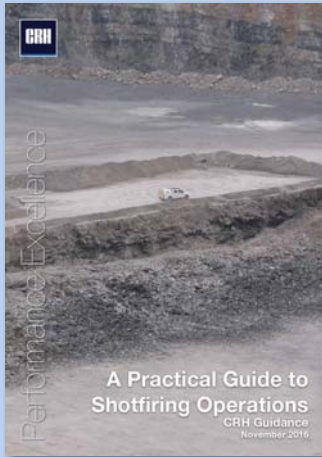

Safety Alerts: Keeping Energy in the Safety Message

Each month, we issue 7 alerts in 14 different languages, 3 of the alerts relate to heavyside activities (this will increase to 4 in 2018), 2 for Distribution and 2 for Lightside activities. Each month we also issue a Best Practice example for each activity.

Heavyside

SAFETY ALERT

Company Name: Aggregate Operator
Accident Date / Time: April 6th, 2015
Injured Parties Details: 43 year old empty
Accident Details (photographs must be included for clarity): A conveyor belt is removed backwards from the moving conveyor. As a result of the



Remote tracking points (in an enclosed channel)

SAFETY ALERT

Company Name: CRH RMC operation
Accident Date / Time: February 19th, 2016
Injured Parties Details: Worker on the curb
Accident Details (photographs must be included for clarity): During a concrete beam structure, one of these sites is



SAFETY ALERT

Company Name: Non CRH operation
Accident Date / Time: September 8th 2016
Injured Parties Details: Fatal accident 58 yrs
Accident Details (photographs must be included for clarity): The victim was operating the dump truck over the beam at the 4 metres below. The



SAFETY ALERT

Company Name: CRH Precast operation
Accident Date / Time: July 7th, 2016
Injured Parties Details: 34 year old production worker with 8 years' experience suffered a significant flesh wound and laceration to his leg
Accident Details (photographs must be included for clarity): At the production process (of hollow core slabs) an employee was hit by a broken pre-stressed cable of 6 bars that was tensioned over a length of 48m. A production worker was placing spacers on a precast production line with fully pre-stressed cables. At the site, another worker was cutting of the loose ends of the fully pre-stressed cables. The cable from which the loose ends had been cut, broke free along the leg and hit the worker on the production line. The incident appeared that the safety bridges on top of the mold where loose or not in position.





Photo 2: this end was cut off by grinder



BEST PRACTICE SHARING

May 2015

Background: A number of companies are using various vehicle performance / driver monitoring systems (Telematics). In addition to improved driver performance in terms of safety a number of companies are also reporting fuel savings as a result of this approach. The use of telematics is one issue which will be covered in the forthcoming Transport Safety Seminar on June 9th in Amsterdam.

Some Details:

- The system structure is outlined in the flow diagram below.
- The bottom table is a performance review listing driver performance against a number of criteria.

Distribution

SAFETY ALERT

21/17

Date and Time: October 23rd, 2017
Accident Details: Fatal Accident - Post party

The deceased had attended the site operating a low loader truck, on behalf of another company (WWM). He was an employee of WWM and was required to collect a quarry vehicle (a CB front end loader) which had been sold by Tarmac as scrap for parts to WWM. WWM specialist in the purchase of redundant mobile plant and then deconstruct the vehicle for spare parts. He received an induction on entering the site as an operator of a truck (A Haulier Industrial).

In the process of preparing the CB for loading onto a low loader truck, which was parked in the site workshop, when the deceased attempted to inflate one of the tyres on the front end loader which was flat using his own compressor unit (drawing from the compressor of his own truck - see photos 1 and 2). While inflating the front offside tyre, the tyre mechanism ruptured and the rotating ring was ejected and struck the deceased (see photo 3). A site operator had been assigned to assist the deceased during reversing, and was present at the time of the accident.





SAFETY ALERT

01/15

Company Name: Non CRH Distribution Company (Travis Perkins, UK)
Accident Date and Time: Fatality - accident occurred in 2013, but legal proceedings have just concluded
Injured Parties Details: Customer - struck by a company vehicle while the customer was loading his vehicle
Accident Details (photographs must be included for clarity): The customer was loading plants of wood onto his vehicle when he struck by a company lorry that was operating in the park - In the subsequent criminal prosecution by the safety authority, the company were fined £2.6m. They were also ordered to pay £143,500 in costs. In sentencing the company, the judge commented that with the level of vehicle movement in the loading areas, "it was an accident waiting to happen". The court also noted that the company had a previous conviction from 2006, when one of its workers was crushed between two vehicles in a similar workplace.



The customer loading area where the fatal accident occurred

BEST PRACTICE SHARING

September 2014

Subject: High intensity blue Light warning system for forklifts. Already in use in some companies (Ancon, Stratus Aquat) it allows pedestrians to stay aware of moving forklifts, in particular at intersections in work areas. Can cover forward and reverse movements. A very simple - cost effective solution to be used in conjunction with forklift warning / reverse control systems.



Lightside

SAFETY ALERT

10/15

Company Name: CRH paving operation
Accident Date / Time: Reported May 29th, 2015
Injured Parties Details: Employee - 33 years old - sustained serious crush injuries
Accident Details (photographs must be included for clarity): The dry site line was in automatic mode when the injured person noticed that the line had stopped. After checking for the reason for the interruption, he discovered that an in-line joint connector on the pneumatic supply line to the product closing clamp was disconnected. The raising/lowering section of the closing clamp was in the low position and closed. The injured party opened the electronically barred door and entered the security area and climbed onto the joint conveyor. To reach the open end of the air supply line he positioned the upper part of his body in the gap between the top of the closing clamp and the underside of the outer frame. The injured party was trapped by the chest between the two horizontal sections - see photo of air isolator on next page. A checklist has been issued to prevent companies in checking all of these key issues on relevant machines - checklists to be completed by July 2016.



On reconnecting the air supply the clamp opened and received the signal to rise up to the top position. The clamp was programmed to raise up to a position 15 centimetres below the underside of the fixed frame. The red arrow indicates the position the clamp would rise to.

SAFETY ALERT

17/16

Company Name: CRH Precast operation
Accident Date: May 19th, 2016
Details of Source, Accident Details: 27 year old suffered broken ribs and a punctured lung. This accident is still the subject of internal and external investigations, but a number of key issues can be highlighted at the time.

Background Information:

- The injured party and the panel operator were on the afternoon shift, which commenced at 1 p.m.
- A supervisor who was in place to manage the shift handover (from the morning to afternoon shift) had been the victim at 1:05 p.m., but the supervisor had left the area around 1:07 p.m. to work with a new employee who was being trained in for a new role.
- Access to the guarded area is possible in three ways:
 - Interlocked access door to the drying chamber
 - Interlocked access gate of 1.2 m high near the input of the machine (photo 1)
 - Interlocked access gate of 1.2 m high near the output of the machine (photo 2) around the wire coil storage area
 - Below all interlocked gates were placed and in addition to sounding a warning siren, opening the gate also activated a flashing warning beacon in the area
- Initial indications are due to a high number of process interruptions (blockages, spills etc.) some operators used a number of unauthorized ways of bypassing the interlocks including accessing the guarded area (with the machine running) by using a gap near one of the interlocked gates.



Photo 1: The arrows illustrate the direction of the output of the product (bottom one table). Position where the victim was trapped in the machine. Access gate to the guarded area. Photo 2: Access gate that was switched off were the victim was likely entered the guarded area -

BEST PRACTICE SHARING

February 2017

Problem Information: Landscaping Bill
Risk assessment of Site Transport - change in traffic flow, and pedestrian routes



Measuring Safety with Leading Indicators

1. **Leadership KPI: Safety Leadership Interactions (SLI's)**
2. **Employee Engagement KPI**
3. **Transport Safety Checks:** Random safety spot check on heavy goods vehicles carrying goods for CRH
 - 5 areas are checked (if one or more of these issues is not in place , the check is deemed a fail/non compliance)
 - Evidence that a spot check has been carried out that working day
 - A pedestrian mirror is in place
 - That the driver has the required PPE (for the site collection and delivery) in the vehicle
 - That the reverse warning system on the vehicle is working
 - That the load is secure (where applicable)
4. **Safety Observations (near miss):** any behaviour, condition or practice which could lead to injury.
5. **High Potential Learning Event (in effect a serious near miss).**

High Potential Learning Event: is an incident which could have resulted in a fatal accident/serious injury if there was a small change in circumstances. A comprehensive list of examples is included:

Definition of a High Potential Learning Event:

- 5.1. Person or persons working on a machine which is not isolated (electrically, pneumatically, hydraulically or mechanically) - this includes electrical work. Machine: conveyor belt, belt drives, rollers, drums, motors etc. Included in this category is:
 - Entrance into an area of the plant where the equipment is still in automatic mode.
 - The deliberate bypassing of an interlocked gate.
- 5.2. A vehicle (site vehicle or visitor vehicle) comes close enough to person to cause the pedestrian to take evasive action.
- 5.3. Any work at height where any one of the following measures where specified in the work instructions have not been carried out:
 - Use of a safety harness
 - Use of MEWP
 - Use of scaffolding
 - Any other measure specified in the work instructions.

This category also includes work at height which was specifically prohibited.
- 5.4. Persons working in trenches where any one of the following measures where specified in the work instructions have not been carried out:
 - Use of trench side support systems
 - Reduction of the slope of the trench sides/walls
 - Any other measure specified in the work instructions
- 5.5. Person detected to have alcohol or drugs in his/her system while on site.
- 5.6. The collapse, overturning or failure of any load bearing part of a:
 - Any lift, hoist, crane or MEWP
 - Any excavator
- 5.7. Any work in a confined space , where the emergency or rescue procedures were required to be used.
- 5.8. Any form of ejection of moving parts from within a machine where there was a risk that persons could have been struck by those parts – examples would includes fluid couplings.
- 5.9. Any burns resulting from hot material which could have had the potential to cause serious injury.



Measuring Safety with Leading Indicators

Definition of a High Potential Learning Event (cont.):

- 5.10. An unintentional initiation of a detonator or ignition/explosion of explosives.
- 5.11. The explosion, collapse or bursting of any closed vessel.
- 5.12. The collapse or partial collapse of any access scaffold.
- 5.13. Any unintended collapse or partial collapse of any building under construction or renovation or any floor of a building being used as a place of work . This category includes the explosion of pressurised equipment (fixed and mobile) such as boilers and cement tankers etc.
- 5.14. Any incident in which plant or equipment comes into contact with an overhead power line/ underground cable or comes close enough to cause arcing. This includes the unplanned unearthing of either Gas pipes or Electrical Cables during excavations of any sort.
- 5.15. Where an object falls from a height close to where people would usually be working within that area or regularly accessing the area.
- 5.16. Any other event ,situation or incident which in the view of the company safety officer inclusion as a High Potential Learning event. This can be agreed on submission of the monthly data.

CRH

Safety Leadership Interaction's (SLI's)





Safety Begins with Me

This cover page features a yellow background with a blue header and footer. The CRH logo is in the top left. The title 'Safety Leadership Interaction's (SLI's)' is centered. Below the title are two images: a blue sign with the word 'LEADERSHIP' and a photo of three men in a meeting. A circular badge in the bottom right corner says 'Safety Begins with Me' with a checkmark.

CRH

Guidance Note: Employee Engagement KPI Health & Safety



Safety Begins with Me

This cover page has a blue background. The CRH logo is at the top. The title 'Guidance Note: Employee Engagement KPI Health & Safety' is centered. Below the title are two photos of employees in a meeting. In the center is a graphic of colorful blocks. At the bottom are two documents: '16 Life Saving Rules 2017' and a 'SAFETY ALERT' form. A circular badge in the bottom right corner says 'Safety Begins with Me' with a checkmark.

CRH

Senior Management Training - Safety



Safety Begins with Me

This cover page has a blue background. The CRH logo is at the top. The title 'Senior Management Training - Safety' is centered. Below the title are three hexagonal photos showing safety training: a worker with a roll of material, a forklift operator, and a worker in a safety harness. A circular badge in the bottom right corner says 'Safety Begins with Me' with a checkmark.

CRH

CRH 2017/18 Safety Campaign



Guidance Note for Facilitators of the Workshop

Safety Begins with Me

This cover page has a teal background. The CRH logo is at the top. The title 'CRH 2017/18 Safety Campaign' is centered. Below the title are several photos showing safety activities: workers in safety gear, a meeting, and a night scene. At the bottom is the title 'Guidance Note for Facilitators of the Workshop'. A circular badge in the bottom right corner says 'Safety Begins with Me' with a checkmark.

Dedicated Safety Sharepoint

A Dedicated Safety Sharepoint was developed in 2014 to provide a support to all operating companies. Key elements of the Safety Sharepoint include:

- A database of all CRH Safety alerts in all languages
- A search function to allow you locate relevant alerts
- A full database of all CRH Health & Safety Guidance notes
- Presentations from the various Safety Best Practice working groups
- Presentations from various Safety events e.g Annual Transport Safety seminar

Please contact your company safety professional to gain access details for this safety site.

Europe Safety SharePoint homepage

The screenshot shows the homepage of the Europe Safety SharePoint. It features a navigation bar with the CRH logo and a search bar. Below the navigation bar, there is a section titled "Life Saving Rules" with a grid of 16 circular icons representing different safety rules. The icons are arranged in two columns of eight. The left column is labeled "Overseas" and the right column is labeled "Distribution".

Handout pg xx Page 1

Safety Guidance

The screenshot shows a page titled "Safety Guidance" with a list of 16 LSR booklets. The list includes titles such as "All CRH Safety Rules", "Health Consciousness", "Standardised Signaling", "All CRH Signals", "Construction Project Safety Manual", "Construction Safety", "Construction Management Handbook", "Working Safely", "Guidance on Internal Transport Safety", "Guidance on Safety in the design and handling of steel and other metal work", "Guidance on general work presentation", "Health and safety in hot areas of cement plants", "Hoisting Safety", "Heavy Safety", "Hot safety guidance", "Hot Work - Guidance on Safety Procedures for the purchase of Hot and Molten", "Hot Working - Storage and use of materials used in the manufacture of cement", "Safety Working - Use in the Hoist Room Team", "Shifting Scales", "Use of Safety of Personal Elements", "The golden rules of access safety", "Work in Progress", "Working at Heights", and "Working near water".

16 LSR booklets and all Safety Guidance is available for consulting and download

Handout pg xx Page 2

Safety Alerts

The screenshot shows a page titled "Safety Alerts" with a list of alerts. The list is sorted by year and month. The alerts are listed in a table with columns for "Year" and "Month". The years range from 2014 to 2015, and the months range from January to December. The alerts are listed in chronological order.

All Safety Alerts from HS, LS and Distribution sorted by year and month

Handout pg xx Page 3

Safety Campaign material

The screenshot shows a page titled "Safety Campaign material" with a section for "Annual Campaign 16 LSR video's". The section displays 16 video thumbnails, each representing a different LSR video. The thumbnails are arranged in a row and are labeled with the names of the LSR videos.

All Safety Campaign video's and booklets are available, video's can be streamed or downloaded

Handout pg xx Page 4

1. HEALTH & SAFETY POLICY STATEMENT

- 1.1. A Health and Safety policy statement must be in place at each company. It should be signed by the Company Managing Director and displayed at every location.
- 1.2. Each company Managing Director is responsible for the development and implementation of an SLI program in their company.
- 1.3. All companies are required to define and document the safety roles / safety responsibilities / expected safety behaviours of management and supervisors by January 2019 (a template will be provided in Q1 2018).

2. SAFETY ADVICE / SAFETY RESOURCES

- 2.1. Every company shall appoint a Health & Safety Officer (full or part-time) who shall provide advice and assistance on implementation of safety policy.
- 2.2. Safety professionals will be invited to participate in a Continuous Professional Development (CPD) initiative for safety professionals (to be launched in Q2 2018).

3. PERSONAL PROTECTIVE EQUIPMENT: MINIMUM REQUIREMENTS

- 3.1. Each operation must have a clearly defined policy for PPE requirements.
- 3.2. While each site can define their own PPE requirements, the following are considered minimum requirements (unless their non use is permitted through a risk assessment completed by a competent internal safety person):
 - Safety Helmet (not bump cap).
 - High Visibility Clothing (see requirement 4 of LSR No.5 on page 41).
 - Safety Glasses (the use of goggles or other tight fitting safety eyewear may be required for specific activities - this should be addressed and identified as part of the site risk assessment. As a general rule safety glasses should be a requirement for all those working in or visiting an operational site.)
 - Safety footwear : Integrated metatarsal boots are required by all contractors and employees working at an operational site- see LSR No.12 on page 80. An exemption to this rule only applies where a site specific risk assessment, completed by a competent internal safety person allows for their non use in specific circumstances).



4. RISK ASSESSMENT / SAFE SYSTEMS OF WORK / PERMITS

- 4.1. Each company must have an appropriate documented system to complete Risk Assessments for all machines/ installations, workstations, processes and manual tasks that identifies and evaluates the present hazards, the associated risks and the necessary control measures that must be taken to prevent accidents/injuries.
 - Identifying control measures must be based on the general principle of prevention taking into account the following order 1) preventing risks, 2) preventing damage/injury, 3) limiting the damage/injury.
 - Risk assessments must be reviewed on a regular basis or in cases where task/job changes occur that increase or change the risks.
- 4.2. Standard Operating Procedures (SOP's) must be developed, implemented and maintained for repetitive tasks. Tasks without SOP's shall have a task risk assessment conducted prior to the work starting.
- 4.3. A permit system to support risk assessment should also be in place for certain tasks (as identified in the site level risk assessments) some examples - LOTOTO, Confined Space, non routine lifting operations.
- 4.4. Construction / Project work such as installation or removal of plant should be accompanied by a detailed Project Risk Assessment.

5. SAFETY TRAINING

- 5.1. In conjunction with the HR function within each company , there must be a training database/matrix in place for Health & Safety Training and Safety Inductions.
- 5.2. Each Company must have in place an annual safety employee training program. Such training must include an assessment and be recorded.
- 5.3. Each operational full time operational employee must receive 12 hours training per year. Again such training must involve an assessment.
- 5.4. Each company must have programs in place to ensure all managers and supervisors receive dedicated safety management training relevant to their position.
- 5.5. Such training , as required by point 5.4 should include as a minimum:
 - Contractor Management: Ref LSR rules 1 and 10
 - Communication Skills: using material such as the 2017/18 campaign Frontline Leader DVD
 - Safety Roles / Safety Responsibilities/ Expected Safety Behaviours
- 5.6. A specific Health & Safety induction process must be in place for all new employees, contractors and visitors. Safety Inductions for new employees and contractors must involve an assessment.
- 5.7. Where safety training , including safety stand downs and toolbox talks are taking place at a site - all contractors working at the site should be included, where appropriate, in such safety events.

6. EMPLOYEE SAFETY MEETINGS / SAFETY COMMITTEE

Regular safety meetings (formal and informal) should be held with employees on relevant safety topics and where possible should include contractors.

7. SITE LEVEL SAFETY COMMITTEE

Each location should have a committee of employees from across the location who will review Health & Safety on a regular basis (formal minutes shall be produced from such meetings).



8. INTERACTIONS WITH TRADE UNIONS ON SAFETY

Subject to local custom and law safety discussions should be held with Trade Unions (if present at a location).

9. ACCIDENTS / INCIDENT INVESTIGATION

- 9.1. All lost time accidents and High Potential Learning Events (HPLÉ's) shall be thoroughly investigated with a focus on root cause analysis. It is the role of the safety professional to ensure the completion of root cause analysis in such cases. The Apollo Root Cause Analysis model is the preferred approach, and training has been provided to internal safety professionals on same.
- 9.2. All lost time accidents and fires must be notified to the relevant SVP (Senior Vice President) or Platform MD (Managing Director) within 48 hours of the LTI occurring. That notification can be by email and include a short description and photograph of the relevant accident.
- 9.3. All serious and fatal accidents must be reported to the relevant senior manager and the central Safety team in Amsterdam as soon as possible after the accident.

10. MONTHLY SAFETY ALERTS / ANNUAL SAFETY CAMPAIGNS

- 10.1. 8 safety alerts are issued each month (4 Heavyside, 2 Distribution, 2 Lightside) in all relevant languages. The Safety alerts are a key element in maintaining awareness of key risks and facilitating effective safety discussions.
- 10.2. Alerts should be used to facilitate discussion at all levels of meetings with operating companies.
- 10.3. The relevant company safety professional is responsible for the distribution of alerts (in the local language) to all key persons within the operating company.

11. CONTRACTOR SAFETY

- 11.1. Only contractors who have successfully completed a prequalification process are permitted to work at a CRH location.
- 11.2. Transport Contractors must satisfy all elements of the CRH LSR No. 10.
- 11.3. Transport Contractors are subject to random safety checks (known as Transport Safety Checks – see page 9)
- 11.4. All contractors must undergo a site induction which must include an assessment, to verify that they have understood the key site risks.
- 11.5. Site Safety Inductions for new employees and contractors must cover the disciplinary procedures for breaches of health and safety, including where relevant “Site Cardinal Rules” – see next point.

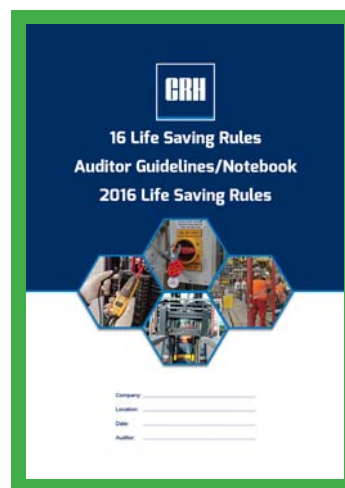
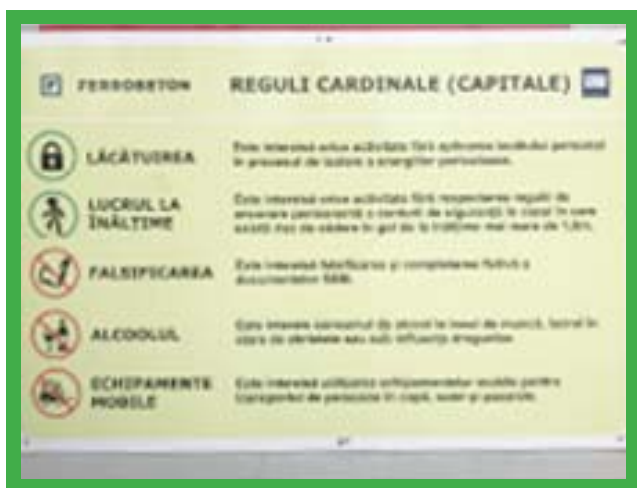

12. DISCIPLINARY MEASURES / CONSEQUENCE MANAGEMENT / CARDINAL RULES

- 12.1. Each company must have a documented disciplinary procedure related to breaches of safety and health requirements in conformity to local law and Trade Union agreements.
- 12.2. All elements of this procedures must be clearly communicated to all employees and contractors are part of the safety induction.
- 12.3. Operating companies should consider the use of a series of site specific rules which if not followed or breached, will result in serious disciplinary action. These site level rules, which could use the term “ Site Cardinal Rules “ would be linked to the most serious safety risk/relevant 16 LSR’s at that operational site. Examples of this approach already in use, will be circulated during 2018 as part of the some of the monthly Best Practice examples . Companies are required to move towards this approach at site level, with all operational sites to have such a set of “Cardinal Rules“ by April 2019.

13. EMPLOYEE INCENTIVES

Whilst this is not an absolute mandatory requirement, safety incentives schemes (e.g. most improved location etc) are strongly recommended to give an ongoing focus to H+S.

14. SITE AUDITS / REVIEWS

Each operating company must conduct 16 LSR self assessment, using the CRH 16LSR Auditor guidelines each year at each site. This annual audit can be carried out by internal or external assessors. These internal audits must focus in detail on all of the management of all contract transport companies working at the location at the time of the audit.

15. DUE DILIGENCE / ACQUISITIONS

- A CRH Safety Due Diligence checklist must be completed as part of any due diligence process. Where applicable the newco integration plan should set out a programme and timetable to ensure conformity to CRH policy and requirements as soon as practical.

16. CAPITAL EXPENDITURE: SAFETY

All capex proposals shall have a Health & Safety assessment completed. Preparation of purchasing specifications should include a reference to the guidance document on safety specification for new plant and equipment (The Red Book - see the CRH Safety guidance section on page 6).

17. TARGET SETTING / PERFORMANCE REVIEWS

- 17.1. Health & Safety performance should be an internal part of the company reporting system and should be reviewed at management meetings.
- 17.2. The safety performance metrics / safety information to be reviewed include:
 - SLI's
 - Safety Observations / High Potential Learning Events / Employee Engagement
 - Recent Safety Audit findings
 - Recent CRH Safety Alerts
 - Non compliance issues within the CRH Transport Safety Checks

18. SAFETY COLLABORATION / SHARING BEST PRACTICE

- 18.1. CRH Europe has a significant safety best practice / collaboration structure. This includes specific working groups on cement/lime, RMC/Aggs, Precast / Paving, Distribution and Lightside and Distribution.
- 18.2. All Companies must ensure that a representative attends the National and European level Safety best practice meetings.
- 18.3. Each company must have access to the CRH Safety Sharepoint (see page 12)

19. EMPLOYEE OCCUPATIONAL HEALTH CHECKS / WORKPLACE HEALTH MONITORING

- 19.1. Health checks should be carried out where applicable for job function, and include pre employment and exit medicals where required under company policy.
- 19.2. CRH has signed up to the CSI (Cement Sustainability Initiative) initiative on Occupational Health which was launched in late 2015. The guidance document entitled "The Health Management Handbook" contains specific requirements which must, where applicable, be met - see LSR No.16 on Occupational Health. (Requirement 8 on page 110).
- 19.3. All companies must have programs in place to meet the requirements of this initiative which focus on noise and dust exposure.
- 19.4. All operating companies must have a risk based annual industrial occupational hygiene plan which covers issues of monitoring of exposure related to noise, workplace dust, hand-arm vibration as appropriate.

20. ANNUAL SAFETY PLANNING / OBJECTIVES AND TARGETS

Every company shall have annual set Health & Safety Targets & Objectives, which are approved and signed by the Managing Director. As a minimum the annual plan must cover the following:

- Programs to ensure full compliance with the 16 Life Saving Rules
- Program of SLI's which covers all senior managers
- Programs to monitor contractor performance
- Program of internal/external audits
- Programs to ensure high levels of housekeeping – including training, audits
- Program to ensure compliance with the CRH Safety training requirements
- Targets for Transport Checks
- Targets for % employee engagement (a KPI to be launched in 2017)
- Review of company compliance with the CSI " Health Management Handbook" (where applicable).

21. SAFETY CLIMATE SURVEYS

- 21.1. These surveys are based around management and supervisor interviews and anonymous employee questionnaires (see results table below). The process is facilitated by external personnel. A number of operating companies have commenced this process in 2017.
- 21.2. The process involves an initial safety climate survey, a program to address the issues raised, and a follow up survey to assess program progress.
- 21.3. Each operating company will have at least one safety climate survey completed at one of their sites in 2018. This initial survey will be arranged, facilitated and resources by the central safety function. The operating companies would then

Safety Climate Survey	AVG%	AVG%	Gap
Safety Values			
Safety Communications			
Management Credibility			
Hazard Correction			
Aligning Conditions			
Behavioural Reinforcement			
Accountability			

develop their own Safety Climate Survey program for 2019/2020.

22. ISO 45001

2018 will see the launch of the new international safety management standard, 45001. Each company will be required to have a representative present for the dedicated CRH briefing sessions which will be provided when the standard is launched.

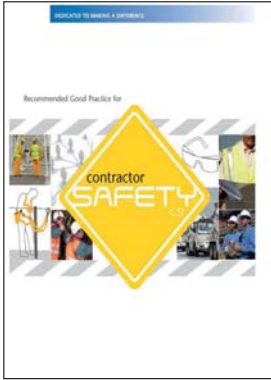

Please note: Contract Haulier / Transport Contractor issues are covered in LSR No.8

Introduction

Contractors and their employees continue to represent a significant proportion of the serious accidents within the Group. Based on this level of risk, it is policy that a robust pre qualification system is in place in each company for the use of contractors.

To ensure that the contractor prequalification system is consistent across the divisions and fulfils a minimum standard, a contractor prequalification system based on the requirements of a prequalification template the CRH Heavy/Light side **“Contractor Safety Checklist” or agreed equivalent.**

CONTRACTOR MANAGEMENT

You are only as strong as your weakest link.

A Contractor is four times more likely to be involved in a fatal accident than an Employee.

The sample **“Contractor Safety Checklist” (or agreed equivalent)** must fulfil the objective of ensuring that, prior to any contractor commencing work at a CRH location, that the operation is aware of the following:

- The details of the people the contractor will be using.
- Information about the previous safety performance of the contractor company.
- Confirmation that the contractor company have systems for ensuring that their plant and equipment is safe.
- Confirmation that the contractor is aware of the safety requirements of CRH.
- The level of supervision in place.

Please note the following key points in relation to the contractor prequalification system:

- The **“Contractor Safety Checklist ” (or agreed equivalent)** is completed by the contractor.
- The operational manager who engages the contractor is responsible for ensuring that the prequalification process with the contractor is completed prior to the contractor commencing work at the location.
- Where contractors are used throughout the year for one operation, the form can be completed once per year.

Example:

where a contract company carry out maintenance throughout the year at different times, that contractor company can complete one Contractor Safety Checklist in January of each year. They are required to list all the procedures and personnel that they will use throughout the year. If the personnel used by the contractor company are different to the personnel listed in the January Contractor Safety Checklist, then the CRH company / location would have to be informed of the change. The same applies where the contractor company carries out a different job or different work than that listed in the January Contractor Safety Checklist, then the CRH company / location would have to be informed of the change. (can be updated if personnel details change).

- Where contractors sub-contract an element of this work, the sub-contractors involved must also complete the relevant prequalification questionnaire.
- The contractor prequalification system detailed above is not required for low risk contractors such as:
 - Security Contractors
 - Office Cleaners
 - Inspection Bodies
 - Personnel repairing office equipment only

One pre-qualification approach will ensure a system which is:

- Consistent
- Auditable

Requirements for Rule No.1

1. All companies must have in place a contractor prequalification system based on “The Contractor Safety Checklist” or similar prequalification questionnaire. Where contractors sub-contract an element of this work, the sub-contractors involved must also complete the relevant prequalification questionnaire. The contractor must provide safe systems of work and risk assessment information relating to the work that they are going to carry out. If the original plan changes then all risk assessments must be reviewed again.

2. The issuing of the “Contractor Safety Checklist” to the contractor firm is the responsibility of the manager or supervisor who engaged the contractor firm in the first instance.

The purpose is to ensure that the “Contractor Safety Checklist” is completed well in advance of commencing work on site. This is to allow a comprehensive prequalification assessment.

Each operation will be required to demonstrate that such a system is in place.

3. All contractors must receive a site specific safety induction prior to commencing work. That induction must outline the site specific requirements around risk assessments and work permits. This induction must include an assessment.

4. Where appropriate, on site contractors must be included in any safety activities such as toolbox talks, safety campaign events etc.

5. From May 2018, all contractors (excluding contract transport contractors) commencing work at an operation must be assigned a CRH person, who has overall responsibility for monitoring the work of the contractor while on site. This responsibility also includes a requirement to conduct regular safety reviews with the contractor. For short term contractors, this would involve a safety review at the end of the contract. For medium and long term contractors, this could take the form of a monthly review. Any review should cover the following:

- Accidents/incidents during the contract work.
- Quality of the site induction and any issues with site safety procedures.

The CRH person will also act as a site contact person for the contractor if they require additional information or if the scope of the contractors work is to change.

These additional requirements will involve some changes to the “Contractor Safety Checklist”. See an updated version of the Contractor Safety Checklist on the safety sharepoint.

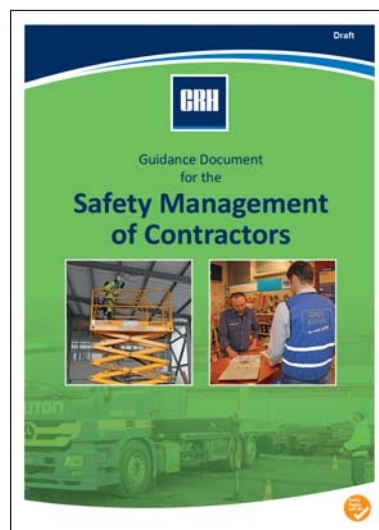

To be developed in 2018



Serious Accident 2014:
Accident involving major contractor firm: lifting gear failure during a lifting operation. Lifting gear certification out of date, task safe system of work incorrect.

FINNSEMMENTI

6.) Forklifts and other moving working machines can only be used by persons who have received training for using the type of equipment in question. Based on the training the driver must give the person a written permit for using the type of equipment in question. This permit must be presented to the contact person of Finnsementti before starting to use the equipment.

Acknowledged

7.) Trucks, bucket loaders and similar machines used continuously for internal traffic within the area of Finnsementti must have a warning beeper, reversing camera and reversing beeper. Forklifts used within the area of Finnsementti must also be equipped with a warning beeper and a reversing beeper but no reversing camera. All machines must have a safety lock preventing the driver from falling from the cabin if the machine turns over.

Acknowledged

I have carefully acquainted myself with the above safety considerations.

Representative of contractor _____ Date _____
 Contact person of Finnsementti _____ Date _____

Attachment: list of contractor's personnel having attended safety training organized by Finnsementti.

FINNSEMMENTI

SAFETY CHECKLIST FOR CONTRACTORS

A representative of the contractor and a contact person of Finnsementti form to fill in this form before the works of the contractor start working within the area of Finnsementti. The form must be given to the local safety manager of Finnsementti.

- **Person:** Mr. Matti Anttonen, tel. 040 551 0517
- **Lappseutu:** Mr. Timo Hänninen, tel. 040 551 0503
- **Terveistö:** Mr. Pekka Kukkonen, tel. 040 513 0414

Place _____ Date _____
 Contractor _____
 Works to be performed _____
 Person in charge for the contractor's part _____ Tel. _____

PART 1. Contractor safety management

1. Has the contractor's safety policy (or equivalent) been delivered to the contact person of FS?
2. Has the document **OBSERVING SAFETY ISSUES WHILE WORKING AT FINNSEMMENTTI OR WORKS** been delivered to the contractor?

FINNSEMMENTTI OY
 Puhelin: 010 200 2000
 Faksi: 010 200 2001
 Sähköposti: info@finnsementti.fi
 Internet: www.finnsementti.fi
 Y-tunnus: 0110136-10
 Kotipaikka: Helsinki
 Työntekijät: 1000
 Vuokratyöntekijät: 1000
 Liikenne: 1000
 Konekalusteollisuus: 1000
 Kone- ja metalliteollisuus: 1000
 Kone- ja metalliteollisuus: 1000
 Kone- ja metalliteollisuus: 1000
 Kone- ja metalliteollisuus: 1000

AS-GS Beurteilung Subunternehmer jura materials

Anhang 1
Beurteilungsprotokoll für Subunternehmer zum Verhalten im Bereich Arbeitssicherheit

Der Unternehmer dieses Protokolls bestätigt, die folgende Festsellung gemacht zu haben:

Subunternehmer: _____
 Mitarbeiter: _____
 Datum und Zeit: _____
 Ort: _____
 Feststellung: _____
 Aufgenommen von: _____
 Unterschrift: _____
 Vom Kabinenbetreiber: _____

* Kopie geht an den betroffenen Subunternehmer

Beitrag zur Sicherheit im Bauwesen
 Betriebsanweisung Nr. 001
 Ausgabe: 01/2011
 Seite 1 von 1

AS-GS Beurteilung Subunternehmer jura materials

Checkliste zur Beurteilung eines Subunternehmers bezüglich AS+GS

Gebäudebewertung:
 Dieses Formular soll vom Subunternehmer/Ansprechpartner zusammen mit dem beauftragten Subunternehmer ausgefüllt werden. Sicherheitspläne, die bei den Arbeiten des Subunternehmers erfordern sind, sollen vorzulegen zu prüfen werden. Insbesondere die Nacharbeiten von Sicherheitsplänen sind nachfolgend zur persönlichen Überprüfung durch die beauftragte Person zu formulieren. Dem beauftragten Subunternehmer ist davon eine Kopie beizubehalten.

Firma/Subunternehmer: _____
Führer: _____
Bewertung/Beurteilung des Subunternehmers: A B C D
Ansprechperson des Subunternehmers: _____
Der Subunternehmer hat Erfahrungen mit den angegebenen Tätigkeiten: ja nein
Datum der letzten Bewertung des Subunternehmers: _____
Ort / Werk / Betrieb: _____ Datum: _____

Freigegebene Mitarbeiter des Subunternehmers:

Name / Vorname	Aufgabenbeschreibung / Qualifikation
1. _____	_____
2. _____	_____
3. _____	_____
4. _____	_____
5. _____	_____
6. _____	_____

Hinweise:

- Die Mitarbeiter des Subunternehmers müssen eine Sicherheitsausbildung erhalten.
- Zur Ausbildung gebührender Arbeiter müssen die Mitarbeiter des Subunternehmers über 18 Jahre alt sein (AVG 1).
- Alle Änderungen hinsichtlich der in diesem Formular aufgeführten Personen / Ausbildungen müssen dem Subunternehmer mitgeteilt werden.

Beurteilungsergebnisse:
 Das Unternehmen „JURA Materialwerke“ in dem Bereich Arbeitssicherheit und Gesundheitschutz“ wird Arbeitssicherheit und Gesundheitschutz (AS+GS) der JURA Materialwerke vom dem Subunternehmer ausgenommen.

Datum: _____

Beitrag zur Sicherheit im Bauwesen
 Betriebsanweisung Nr. 001
 Ausgabe: 01/2011
 Seite 1 von 1

Group Fatality Data: 2003 - 2017

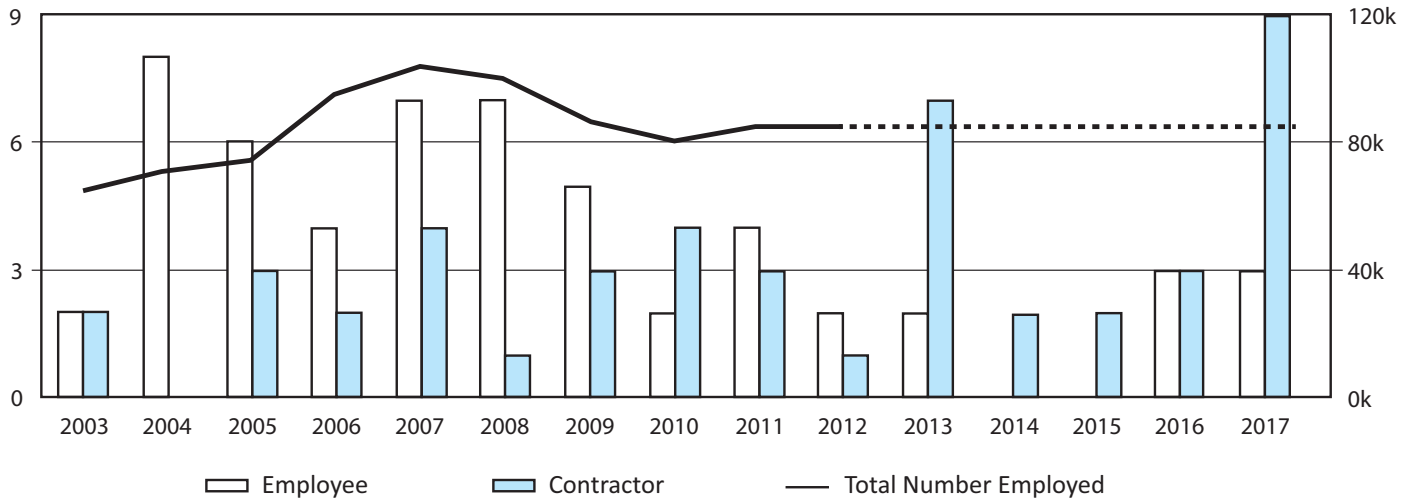

Best Practice Example:

Contractor Management. For operations at Opterra each contractor coming on site comes under the responsibility of a Opterra employee. That employee has responsibility for the ongoing monitoring of the contractor once on site.

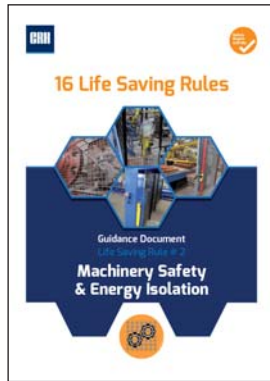
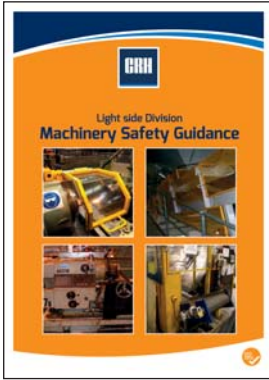

Introduction

There have been a very significant number of fatal and serious accidents involving persons

- becoming trapped in machinery due to inadequate guarding
- becoming trapped in machinery having accessed protected areas
- becoming trapped in machinery and emergency stop cords failed to operate

Fatalities involving machine interlocks integrity are outlined on the following page. Fatalities within the group relating to inadequate guarding can be summarised as follows.

Year	Fatality Details: Machinery Safety
1999	Contractor trapped in unguarded return roller
2001	Contractor trapped in conveyor roller
2005	Contractor trapped in conveyor belt
2007	Contractor trapped in conveyor tail drum
2016	Contractor trapped in Conveyor NIP Point
2017	Contractor trapped in Conveyor Tail Drum
2017	Contractor engulfed after Pneumatic slide was started when he was in a chute underneath.

This Life Saving Rule focusing on the following aspects:

- Machinery Guarding standards.
- Where interlocks are in place, to ensure the integrity of such systems.
- Technical requirements for emergency stop buttons and trip cords.
- The need to review the need for start-up warning alarms as a last line of defence.

The specific requirements for Life Saving Rule No.2 are outlined on page 26.

Machinery Guarding Standards

The following technical guidance documentation has been prepared to assist operations in complying with the requirements on machinery guarding. This guidance can be used when carrying out machinery safety inspections, risk assessments and when formulating safety training courses.

- **16 Life Saving Rules guidance document on Machinery Safety** which incorporates the U.K Quarry Products Association “Code of Practice for the Safeguarding of machinery used in the aggregates industry”- this guidance contains pictorial guidance on guarding and isolation requirements.
- **Machinery Safety in Lightside activities:** this is an internal guidance document which contains pictorial guidance on guarding and isolation requirements.

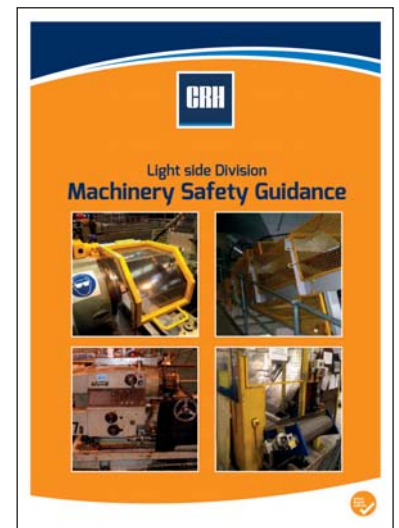

The Integrity of Interlock Systems

There have been a number of serious accidents within the group, where interlocks have been bypassed by maintenance staff.

Year	Fatality Details: Energy Isolation
2000	Maintenance person crushed by pallet clamp during maintenance
2001	Contractor crushed during commissioning of machinery
2001	Employee crushed by brick setting machinery
2004	Employee struck by automated machinery while carrying out maintenance
2005	Employee trapped inside cuber machine
2005	Employee trapped in polystyrene block feeder
2007	Employee accessed an EPS cutting line to clear a blockage, was trapped and killed
2009	Employee entered an interlocked area and was trapped and killed between a slider and column
2011	Employee accessed a brick gripper area and was trapped and killed

Each company must introduce a system of formal checks on all interlocks to ensure integrity i.e that they have not been bypassed. Interlock systems should be connected to a failsafe circuit. Experience indicates that attempts to bypass interlocks are indicative of a production or maintenance issue that can be easily addressed placing the guard close to the machine to allow easier visual inspection and installing features such as remote greasing points.

Where inspections reveal that machine interlocks were being by passed, a management assessment must be carried out to identify the cause(s) leading to such a by-pass (the bypassing of an interlock is a serious breach of safety procedures and will result in significant disciplinary action).

Emergency Stop Systems

A Conveyor trip switch, when activated, should open a pair of contacts that are electrically connected to a failsafe circuit. This electrical failsafe circuit has to be risk assessed and engineered, so that the necessary measures are taken to ensure the reliability of this failsafe circuit. At the same time the trip switch has to operate a latching mechanism which keeps the contacts open. The setup should be such that having reset the emergency stop button or trip wire the machine does not restart.

For all Conveyor Trip wires, the following applies:

1. Technical Specification

- a) Either a switch is provided at each end OR
- b) A single switch is used at one end and a tension spring anchors the other end so that a pull on the wire in any direction will stop the conveyor.

2. Testing (conveyor trip wires and emergency stop buttons)

It is important that all trip wires are tested regularly i.e physically checked to ensure latching performance, and also to ensure that the switches have not seized up - the following are the requirements:

- Trip cords and emergency stop buttons must be tested at least once per year.



MACHINERY SAFETY: SAFETY RULES TO LIVE BY



Conveyors SHALL

only be operated with approved guarding in place



Workers SHALL

LOTOC/LTT all energy sources before doing maintenance



Workers SHALL

LOTOC/LTT all energy sources before cleaning & clearing jams



Workers SHALL NOT

modify, misuse or remove controls, interlocks or warning devices



Workers SHALL

keep clothing, tools, body parts and loose hair away from conveyors



Workers SHALL NOT

climb, sit, ride, stand, touch, or walk on or walk under exposed conveyors



Workers SHALL

be trained and competent to operate & maintain conveyors



Workers SHALL

know the location and function of all stop & start controls



Workers SHALL

ensure everyone is away from conveyors before starting



Workers SHALL

report all unsafe conditions and behaviours



Fig. A
Required Electrical Isolation Switch type



Fig. B
Required Pre-Start Warning Alarm with
combined Siren and Flashing Light

Requirements for Rule No. 2

1. All machinery must be guarded in accordance with the CRH guidance which applies to your operation, namely:
 - The CRH Machinery Guidance document on Machinery Safety (incorporating the QPA Technical Guidance Document).
 - The Lightside Machinery Safety Document.
2. From the requirements / guidance mentioned above in 1, attention is drawn in particular to the following requirements:
 - All machinery guards must be fixed. This means that an engineering tool is required to open the guard.
 - Screw Conveyors must be secured in such a way that an engineering tool is required to remove them.
3. All interlock systems must be tested and inspected monthly by a competent person. The Site Manager is responsible for ensuring such a system is in place.

Where interlock systems have been found to be bypassed, the reasons for such modification should be investigated and identified.

4. Each machine which relies on interlocked gates or interlocked guards must:
 - Have a specific risk assessment, which clearly identifies:
 - Which circuits and relays are deployed when an interlocked gate or guard is opened/removed. This is to clearly identify what is controlled (and not controlled) by interlocks.
 - Pneumatic / Hydraulic power sources.
 - Pneumatic / Hydraulic isolation sources.

Technical requirements around interlocks are included in the CRH guidance note on Machinery Safety / Energy Isolation.

5. All conveyor emergency trip cords must be configured in such a way that there is a switch at each end or a single switch at one end and a tension spring anchors the other end.
6. As a minimum, all emergency trip cords and emergency stop buttons must be tested at least once per year. Each operation will be required to have evidence of such inspections and testing.
7. Machinery Safety: Safety Rules to live by (see page 25) must be integrated into machinery safety training programs.
8. Emergency stop buttons fitted to electrically driven and mechanically driven machines such as motors, presses and rollers have to be clearly marked – see examples on page 27.
9. All electrical isolation switches should be such that it is only possible to lock the isolator in the off position. (Fig. A on page 25)
10. All conveyor belts must be fitted with pre-start warning alarms with an appropriate delay time and a combined acoustic/light warning system. (Fig. B on page 25)

Group Fatal Accident - Case Study

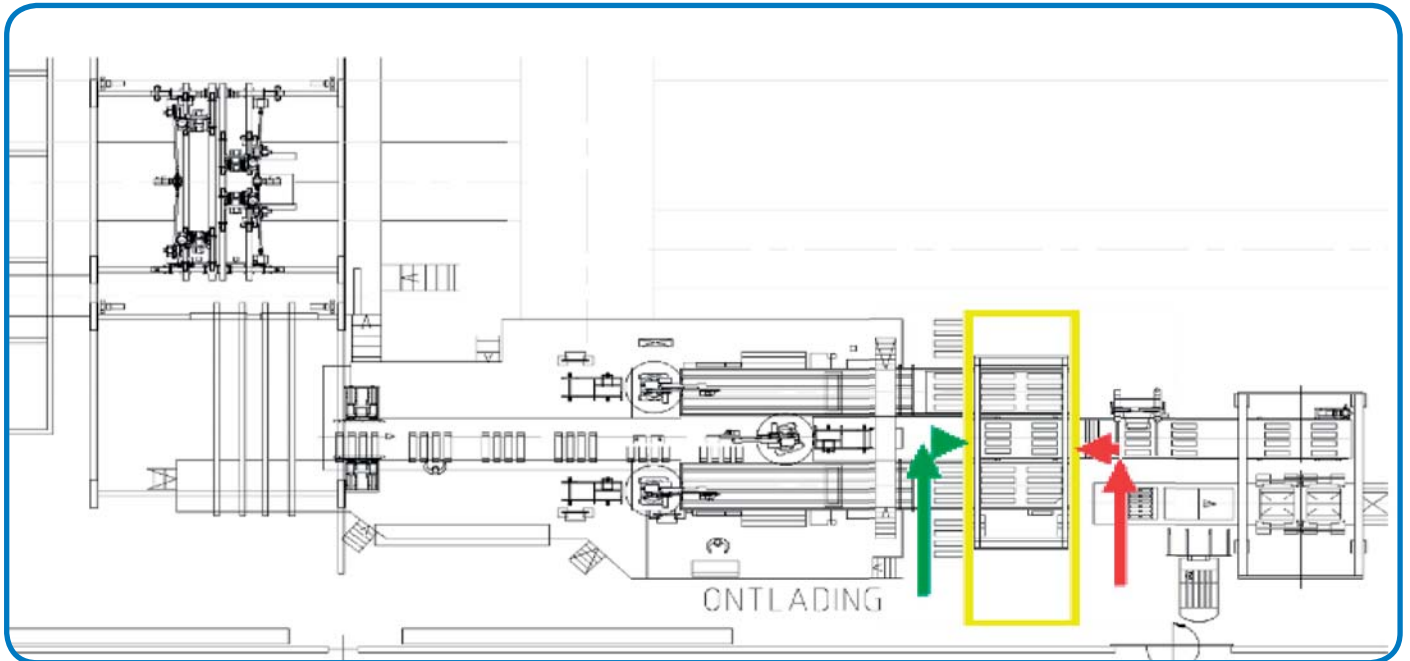

Fatal Accident April 2011 - CRH Brick Factory:

A gripper (outlined in yellow) was protected on one side by an interlocked system. The assumption had been that staff would access the gripper using the route outlined by green arrows and would activate the interlock system. However a short cut through the route highlighted by the red arrows had developed, this access point was not protected.



Serious Accident 2005:

Operator sustained serious injuries when he became trapped in a tail drum.



Emergency Stop





Serious Accident - Case Study 2013:

Employee lost both hands after they became trapped in a machine producing plastic dimpled sheets.



Serious Accident - Case Study 2014:

Employee sustained serious hand and arm injuries when he was trapped between the discharge doors of a bucket and the bucket frame.

Serious Accident - Case Study 2014 :

Employee removed cement screw cover and became trapped in the screw which was still running and had not been isolated.



Remote greasing to prevent the need to remove the machine guard.



Inspection hatch (with secured grid) on a screw conveyor.

*Contractors working on Feeder
(which was off, but not isolated).*



*This belt (which was not isolated)
was started – deceased was
standing on this belt.*

*June 21st 2017:
26 years old employee of a maintenance contractor fatally injured.*

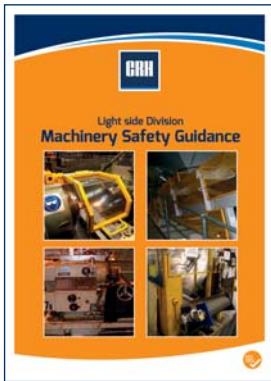

Introduction

There have been a very significant number of fatal and serious accidents involving persons becoming trapped in machinery due a failure to follow the correct isolation procedure, a number of these accidents have been outlined on the following pages. The concepts Lock Out Tag Out Confirm (LOTOC) or Lock Out Tag Out Try (LTT) are both used and are based on the same principle. It is important that there is a consistency in the understanding of the term “Energy Isolation”.

“Energy Isolation” relates to the following sources of energy:

- Electrical
- Pneumatic
- Hydraulic
- Mechanical/Gravitational
- Thermal
- Residual energy in machine component parts
- Material flow

Year	Fatality Details
2000	Maintenance person crushed by pallet clamp during maintenance
2001	Contractor crushed during commissioning of machinery
2001	Employee crushed by brick setting machinery
2004	Employee struck by automated machinery while carrying out maintenance
2005	Employee trapped inside cuber machine
2005	Employee trapped in polystyrene block feeder
2007	Employee accessed and EPS cutting line to clear a blockage , was trapped and killed
2008	2 contractors fatally injured when a mill was restarted while still working within it
2009	Employee entered and interlocked area and was trapped and killed between a slider and column
2011	Employee accessed a brick gripper area and was trapped and killed
2016	Employee trapped in conveyor belt
2017	Contractor trapped in conveyor belt
2017	Contractor engulfed after Pneumatic Slide was opened over an area where he was working.

Requirements of Rule No.3

1. Each location must have a documented LOTO/LOTOTO policy incorporating machine specific LOTO/LOTOTO rules.
2. That policy must cover the 7 energy sources outlined above. Operations will be required to have evidence that the various energy sources have been considered in machinery risk assessments.
3. Employees, who are involved in any element of LOTO/LOTOTO procedures, must be trained in the policy and associated procedures. Such training must be carried out on an ongoing basis and the interval of such training should not be less than one year.
4. All Isolators must be clearly labelled to identify the item of equipment that they isolate. In addition to padlocks, hasp locks (see photograph on page 34) must also be in place as part of all Isolation safe systems of work.
5. All employees and contractors involved in LOTO/LOTOTO must be issued with their own personal padlock and identification system to be attached to the isolator as part of the LOTO/LOTOTO procedure.
6. Isolation owner: When multiple persons are involved in a LOTO/LOTOTO procedure, a multi hasp or lock out box must be used and a CRH person must be nominated whose padlock is the first attached and the last lock to be removed. LOTO/LOTOTO procedures and site specific information relating to LOTO/LOTOTO must be included in the site safety inductions (for employees and contractors) which must include an assessment.

Requirements of Rule No.3 (cont.)

7. Each item of equipment which relies on interlocked gates or interlocked guards must:
- Have a specific risk assessment, which clearly identifies
 - Which circuits and relays are deployed when an interlocked gate or guard is opened/removed. This is to clearly identify what is controlled (and not controlled) by interlocks.
 - Pneumatic / Hydraulic power sources.
 - Pneumatic / Hydraulic isolation sources.
8. Standards for Mould change on machines with face feeder sections:
- Mould changing must be carried out according to site level risk assessment and safe operating procedures including machine specific LOTOTO/LOTOC.
 - This procedure must include photographs of the various steps to be taken in the mould changing process. A sample is available on Sharepoint.
 - This procedure must be a 2 man operation unless there is an automatic mould loading feature.
 - Drive back face feeder section to the isolation position and remove the mould from machine following the documented procedure.
 - After cleaning place the new mould in the machine as per the procedure.
 - Where the power system of driving the face feeder section into position is a hydraulic system, there is an additional risk in the lack of a slow speed mode, so the following procedures must apply.
 1. All adjustments to the back feeder section and the mould positioning must be completed.
 2. All operators involved in the mould change must have vacated the machine area.
 3. The moving of the face feeder section to its operation position must be performed from the main operating panel.
 4. If local conditions only allow for the moving of the face feeder section from a local panel, then the panel must be located at safe distance (+ 2.0 meters) from the locking position.
 5. When the face feeder is in the locking position, isolation (LOTOTO/LOTOC) must be in place where manual bolting of the face feeder section to the main frame is required.
 6. Only after the locking and ensuring that all sections are connected and may the operator remove LOTOTO/LOTOC.
 7. At this stage the machine is ready to be put into operation mode.
 - In addition to the procedures where the power system of driving the face feeder section is electrical there must be a slow mode and an enabling button/dead man switch (wired to a safety-controller/relay) in use for moving the unit.
 - For machines that require any movements to be controlled inside the enclosure best practice would be to use an enabling/dead man switch for all such movements. See the picture.

Use of an audible alarm or bell that goes off prior to any movement would also alert other operators in the vicinity of the work zone.
9. All electrical isolation switches should be such that it is only possible to lock the isolator in the off position. (Fig. A on page 32).





Required Electrical Isolation Switch type.



Required Pre-Start Warning Alarm with combined Siren and Flashing Light.



2016 Fatal Accident - Lime Works:

2 employees were replacing rubber skirting around a discharge point . The belt had been shut down for maintenance (by another team of maintenance personnel) with full isolation (LTT/LOTOC). The isolation was removed at the far end of the line to run a belt for a few moments (to clear material from a build-up at another discharge point) - the team that had restarted the belt believed the other team had completed their work. Neither of the two employees had applied their personal locks. One of the employees was killed when the belt restarted.

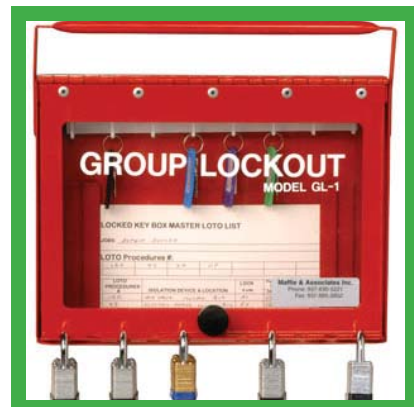



2015 Accident:

An employee placed this bar through a conveyor guard to remove a material build up. The bar was trapped in the moving nip point resulting in the bar and the worker's hand being pulled inwards. The worker lost the top section of his middle finger on his right hand and sustained soft tissue damage to the thumb of his left hand.



Training boards for LOTOTO/LOTOC . These boards which are designed individually contain a number of scenarios which are used to train and assess trainees (on a one to one basis) on the issue of Energy Isolation and lockout.



Pneumatic Isolation



Clearly identified pneumatic isolation point.



Mechanical Isolation: protecting a sliding door (Mechanical + Padlock).



Mechanical Isolation: protecting a sliding door (Mechanical + Padlock).



A confirmation check that all residual air has been vented from the system.



LTT or LOTO



2015 Accident:

Operator reattached an air joint connector which had become loose on the pneumatic supply line to a clamp. The injured party opened the electronically barred door and entered the security area and climbed onto the pallet conveyor. On reconnecting the air supply the clamp by reaching through the gap shown below, the clamps reactivated, moved up (to the position indicated by the red arrow) and squeezed him – he received serious injuries. Entry into the area was not protected by interlocked gates and the failure to vent the air system of residual air was a contributory factor (the air dump/vent valve had been located close to the control position).



2016 High Potential Learning Event:

An employee was carrying out a maintenance task, having attached his isolator, he tried to start the machine (The Try Out (TO) or Confirm (C) step). The machine started and on investigation it was found that the isolator was faulty.



Contractors working on Feeder (which was off, but not isolated).

This belt (which was not isolated) was started – deceased was standing on this belt.

*June 21st 2017:
26 years old employee of a maintenance contractor fatally injured.*



Visible Cut-off Switch (VCS) a recent design where an operator gets a visual confirmation of the isolation.



Introduction

There have been a very significant number of fatal and serious accidents involving persons being electrocuted or burned (a number of these accidents are summarised on page 38).

A guidance document: CRH Electrical Safety Guidance has been developed to assist operations to comply with this rule.

Requirements of Rule No.4

1. Each operational site must have a list of electrical equipment or an electrical survey completed. As a minimum this information must cover the following:
 - A list of all electrical installations at the site.
 - Confirmation that the electrical line/circuit drawings are up to date.
 - A summary of maintenance requirements for the electrical equipment.
 - Emergency shut off devices are in place at each installation.
 - LOTO/LTT facilities are in place.
 - There is a scheme in place to restrict access to electrical panels and enclosures, transformers and substations.
 - All installations have the correct IP rating for the location and activity.
 - Confirmation that the electrical distribution systems likely to be affected by lightning are fitted with over voltage protection.
2. The CRH Europe electrical guidance includes a checklist which must be completed at each operation once per year (or shorter intervals if required by local/national legislation) by a competent qualified electrician (internal or external) and this checklist must be available for inspection. The completion of this checklist for each operation each year is a mandatory requirement.
3. Each operational site will be required to show evidence that electrical supply cables subject to physical damage have been identified and replaced by reinforced / strengthened cables.
4. Each operational site must comply with the requirements from the CRH Electrical Safety Guidance document.
5. All electrical contractors must be externally accredited (accreditation to be defined at country level) and all internal electrical people formally authorised by plant management.
6. A portable electrical equipment colour code system must be put in place by January 1st 2019. Each minimum 12 month period will have a specific colour e.g yellow. Portable Electrical Equipment which has an inspection tag which is that colour i.e a yellow tag is an indication that the equipment has been checked and tested within that period (minimum 12 months). All users of portable electrical equipment would then be instructed to only use equipment with correct colour code tag for that period. See example photo on page 39.



June 22nd 2017:

Contract Electrician received serious burns to hand and face when a non-insulated screw driver made contact with live elements of a panel causing a "flashover". Procedures were not followed and the electrician used the incorrect type of tool (photo A) and not the correct insulated type (photo B).



Fatal Accident 2011:

Employee picked up cable which was damaged. He received a fatal electric shock.



2015 Accident:

A contract electrician received superficial burns to both his hands whilst removing a fuse compartment in the control room sub station at Croxden Quarry. The incident was the result of an electrical arc in the panel.



Fatal Accident 2012:

Electrician was changing light bulbs when he suffered an electric shock- the electrical isolation of the circuit had not been confirmed.

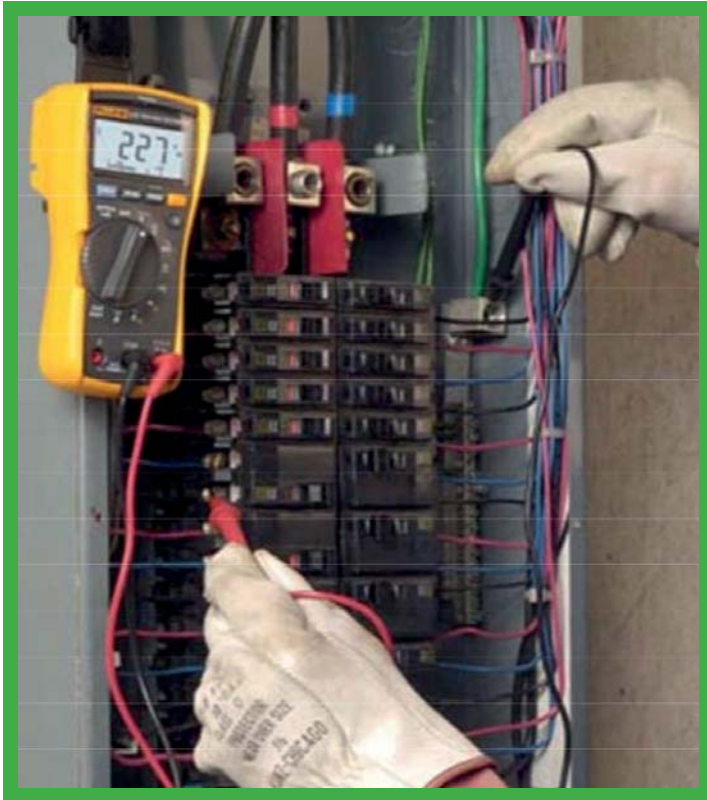

A Digital Multi-Meter.



All live touch points shrouded and covered.

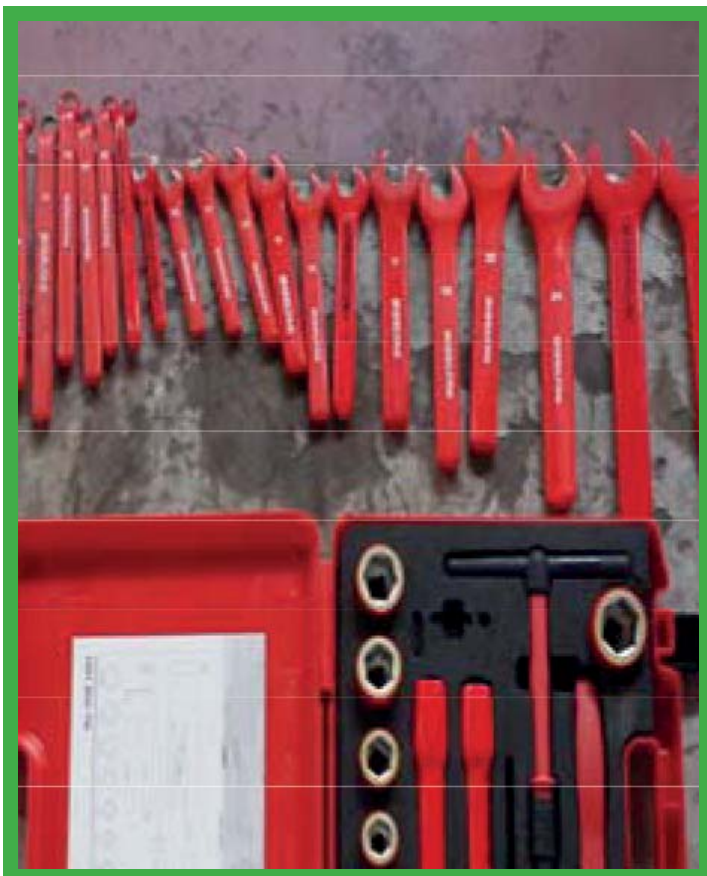

Insulated Tools



Instructions for all users of portable electrical equipment to only use equipment with correct colour code tag for that period.



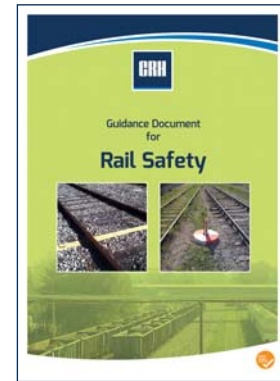
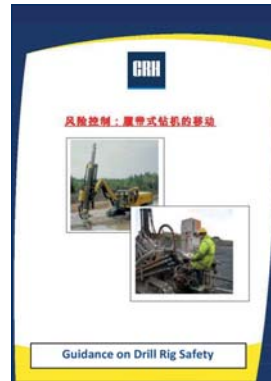
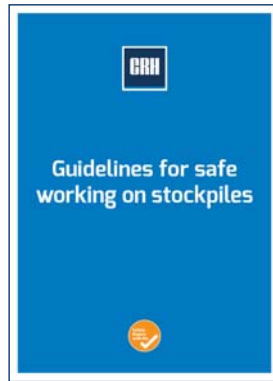
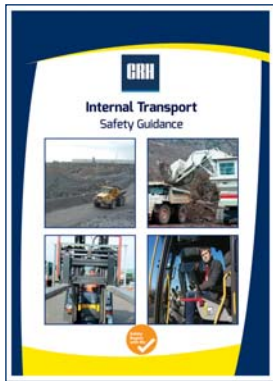

Introduction

Accidents involving mobile plant account for over 60% of fatal accidents within the aggregates industry. This rule is designed to focus on the key accident causes within this sector.

Year	Fatality Details
1997	Contractor struck by a reversing RMC truck on site
2001	Dump truck driver killed when vehicle overturned
2004	Contractor struck by reversing excavator
2004	Employee struck by reversing truck on site
2006	Truck struck an overhead power line on a road surfacing project – driver was killed when he touched the truck
2007	Contract HGV driver killed when truck went off a public road
2007	Contract HGV driver crushed between his vehicle and gate after he left the truck and did not engage the handbrake
2013	Excavator struck a control cabin where a worker was situated, the building collapsed killing the worker
2014	A truck driver stopped on a public road to check the security of a load of pipes he was transporting when the load fell onto him
2014	Contractor struck and killed by rail wagon during repair
2016	Employee struck and killed by forward moving truck

Note: Issues relating to Forklift Safety are specifically referred to in Life Saving Rule No. 6



2016 Fatal Accident - RMC Plant:

A worker was using a water hose to clean a yard. At the same time a RMC mixer was being cleaned out (engine running). Following the cleaning operation, the RMC mixer started to move forward. The driver was looking to his left, where his view was blocked by another RMC truck (see photo).

While moving forward the driver did not see the worker (cleaning the yard) and he ran over him.

Requirements for Rule 5

1. Each location must have documented site transport rules in place, based on a site transport assessment which, at a minimum, address:
 - a) Vehicle / Pedestrian separation: This must include a site transport risk assessment. In effect this is an overview of truck, car, site mobile plant and people flow / movement. See a worked example in the CRH Guidance note “Internal Transport: Safety Guidance” (pictured here).
 - b) Edge protection for slopes/benches.
 - c) Mobile plant driver competency and training requirements.
 - d) Vehicle rules –
 - a. Speed limits / restrictions.
 - b. Use of mobile phones.
 - c. Mandatory wearing of seat belts by all drivers for all vehicles.
 - d. Carrying of passengers in vehicles. Passengers must only be carried in vehicles where there is a separate seat.
 - e. **Vehicle towing:** Prior to towing, it is necessary to ensure that:
 - A risk assessment must be completed, which consider aspects such as suitability of towing vehicle, competence of personnel, proximity of vehicles, slope & gradient, attachment points, exclusion zone etc.
 - Only certified towing ropes or slings(non steel) or fixed draw-bars may be used for towing. They should be regularly examined.
 - Chains/Slings used for towing must never be used for lifting and should be clearly labelled “ Towing Only”.

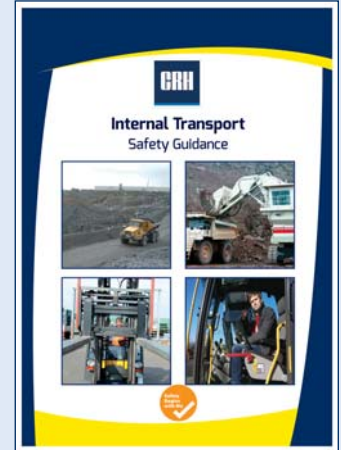

A guidance document outlining specific guidance and a significant number of examples is available to assist in full implementation of this rule.

2. All loading shovels, dozers and dump trucks must be fitted with CCTV systems and external flashing beacons. The need for CCTV's on excavators should be based on a site risk assessment.

All site vehicles/mobile plant must be fitted with reverse warning alarms and concave and convex mirrors.

 - All site heavy vehicles working in areas where there is a risk of material falling onto the cab of that vehicle must be fitted with a FOPS (Falling Object Protection System) Structure.
 - All site heavy vehicles working in areas where roll over could occur must be fitted with a ROPS (Roll Over Protection System) Structure. See accidents photos on page 47.
3. A system must be in place to ensure that a documented pre start check is carried out on each work vehicle at the start of the working shift.
4. Each site must have a policy which requires all employee, contractors and visitors to wear high visibility clothing where appropriate. High Visibility bibs/vests must not be used by production/maintenance staff as they may become open/ loose and present a hazard. In such cases, high visibility overalls or polo shirts should be used. High Visibility clothing must be of yellow or orange colour with reflective banding (such high visibility clothing should comply with EN ISO 20471).
5. A system must be in place to ensure that the brake systems on dump trucks and loading shovels are tested at least twice per year.

Requirements for Rule 5 (cont.)

- All employees operating site vehicles (this does not include company cars for use on public roads) must be trained, and must carry out documented daily pre-use company vehicle inspections for both on-site and off-site use. Employees operating site mobile plant must receive regular refresher training. This refresher training for employees must be carried out at a minimum of **every 3 years** and must include an assessment by a competent instructor of the plant operator actually operating the item of mobile plant. This requirement does not apply to construction projects where contract mobile plant operators hold evidence of competence from accredited external bodies.

The 3 year interval for employees is to recognise the high level of risk involved with site vehicles. The refresher training does not need to be a time consuming process, it can simply involve a competent instructor observing a driver operating the vehicle for 45/60 minutes to ensure that no bad habits or poor practices have evolved since the driver's initial training.

- Edge protection must be in place on haul and access roads within the operation to prevent a vehicle going over an unprotected edge. The height of this edge protection must be equal to a minimum of 1.5 metres or half of the diameter of the wheel of the largest site vehicle using that road. Haul road widths and gradients must comply with the diagram outlined on page 48, unless a risk assessment of existing conditions has been completed and it is deemed not necessary.
- All employees who drive on a public road on company business should be assessed as to a need to have refresher training. Each company can define the criteria for the selection of personnel for such training, but it is envisaged that personnel driving in excess of 10,000km (6000 miles) per annum on company business should have a form of refresher training (to be defined at country level) at least every 3 years. The new and reduced threshold (10000km) for which training will now be a requirement will apply from January 2019.



Personal Protective Equipment: see point 3 of the Minimum Mandatory Framework on Page 13.

Requirements for Rule 5 (cont.)

9. Railway Safety

- All personnel with responsibilities relating to any aspect of planning , operation or maintenance around railway operations must hold evidence of competence in their area of responsibility from an accredited external body or from an accredited internal training program.
- An overall risk assessment for railway activity must be completed covering, as a minimum, the following:
 - Contacts between trains, head to head and head to tail.
 - Contacts between trains and other things (e.g. vehicles, workgroups, plant, machinery and equipment, people and animals).
 - De-railing and re-railing.
 - Decoupling during the journey or shunting.
 - Shunting.
 - Yard shunting (other than by locomotives) .
 - Locomotive/load characteristics.
 - Unexpected operator/s incapacity and impairment of operators (including traffic controllers).
 - Procedures and rules around chocking.
- The indicator which denotes the safe parking point must be clearly visible - see examples on page 44.

10. The CRH guidance note “ Work near water” must be used when devising risk assessment for work or vehicle movement close to water – see LSR No. 12, requirement 13.

11. A minimum “2 metre rule“ applies to the operation of workplace vehicles and it is the responsibility of each driver to observe this rule. The 2 metre rule states that there must be no person within 2 metres of the vehicle, before the driver will operate the machine.

12. Any tasks related to maintenance of vehicles (inflating or topping up tyres, jumpstarting batteries, cleaning of vehicles etc.) can only be undertaken by authorised employees, contractors and third parties – this authorisation must be from site management and include an assessment of risk for the particular task.

- Any tyre inflation (for heavy mobile plant), once authorised must only take place using tyre restraining devices and airlines of sufficient length to allow the user to stand safely to the side (see photos on page 47 and 48).
- All locations where tyre inflation for heavy mobile plant is carried out should consider the example shown on the top of page 40, which allows for access controlled and pressure controlled tyre inflation.
- All locations where battery charging or jump starting of batteries is carried out must have site specific procedures to cover these tasks.

13. A warning notification (similar to the example at the top of page 45) should be in place outside site workshops/vehicle maintenance areas . A similar warning notification must be also in place making it clear that any vehicle maintenance (tyre inflation, battery charging , window cleaning) can be carried out in this area only with specific authorisation from the site manager. The purpose of this requirement is to ensure transport contractors using the site do not carry out unauthorised ad hoc vehicle maintenance on site.



Markers to clearly identify the required holding position for parked wagons.



2014 Accident:

An employee was standing on the access steps of the locomotive (using a remote control). The locomotive struck a wagon that had rolled onto the main track from a siding. The wagon brake was not engaged and the wagon was not chocked.

ATTENTION ALL VISITORS

Do not enter unless authorised by staff

THE FOLLOWING HAZARDS OCCUR IN THIS WORKSHOP

COMPRESSED AIR & GAS	HARMFUL FUMES	ARC / GAS WELDING
HARMFUL CHEMICALS	FLAMMABLE MATERIALS	NOISE HAZARD
MOVING VEHICLES	FLOOR HAZARDS	MOVING EQUIPMENT
DUST HAZARD	METAL GRINDING	OVERHEAD HAZARDS

DANGER

Please go to reception

No smoking no naked lights **No eating or drinking**

WORKSHOP CAN ONLY BE USED BY PERSONS AUTHORISED IN WRITING BY SITE MANAGEMENT



PPE requirements specified at site entrance.



A sign such as this, in compliance with local legislation, must be in place outside site workshops/vehicle maintenance areas.



Accident at Baulking:
Collision between a Forklift and a truck being loaded.

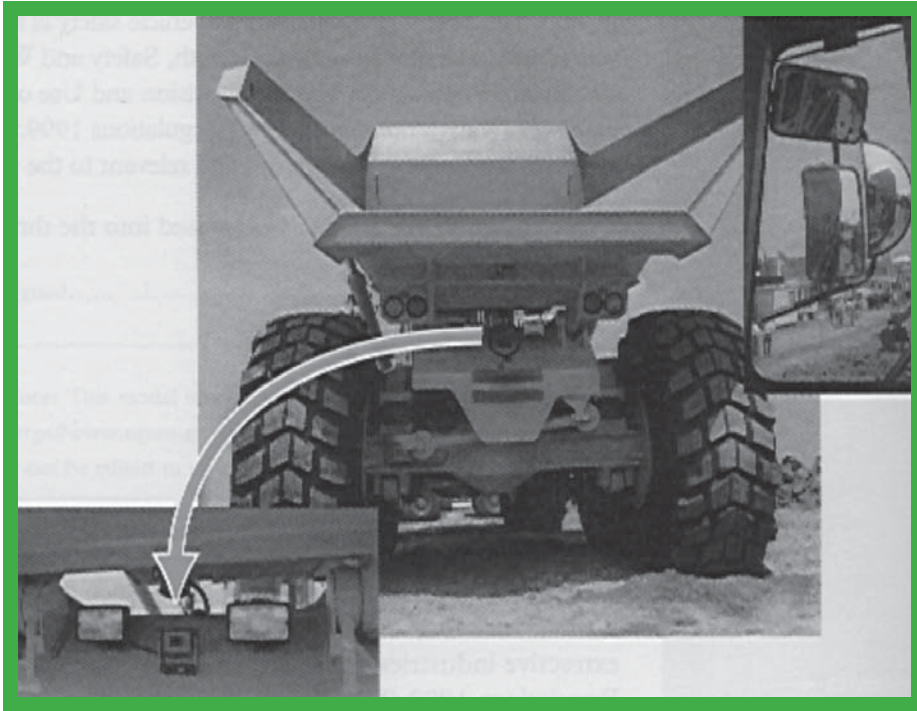

*Group Fatal Accident - Case Study 2004:
Foreman fatally injured when he was run over by a vehicle reversing off the weighbridge.*

*Group Fatal Accident - Case Study 1998:
Foreman run over by a reversing dump truck.*



There are 3 persons in this photo - can you spot all 3?



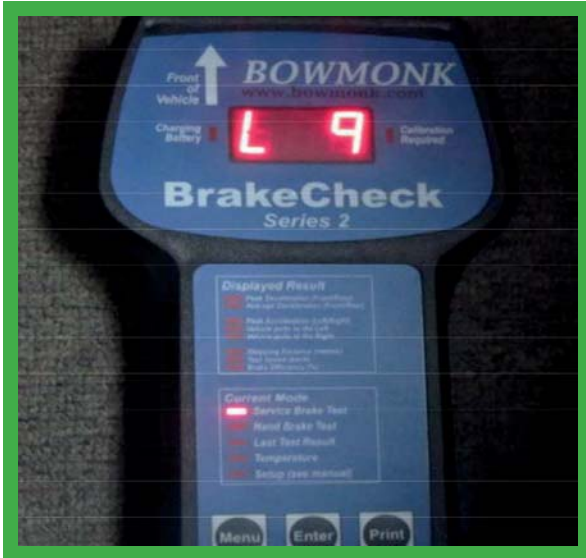



Brake tester for large site vehicles.



2 Metre Rule displayed clearly on vehicle.



<p>10% < slope < 15% Put in place the following sign "Dangerous Descent"</p> 	<p>15% < slope < 20% Modify the ground to bring the slope to 15% - if this is not possible put a sign in place stating " Dangerous Descent " and also limit access to the road to authorised vehicles only.</p>  <p>USE 3RD GEAR AND USE THE RETARDER</p> <p>NO ACCESS FOR HEAVY GOODS VEHICLES</p>	<p>Slope > 20%</p> <p>Not allowed for use</p>
---	---	---

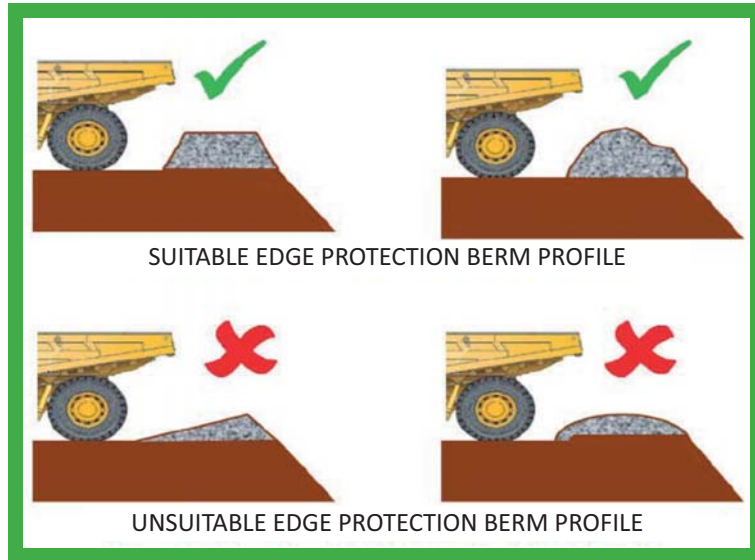

Safety Banks in practice.



Edge Protection using precast structures.

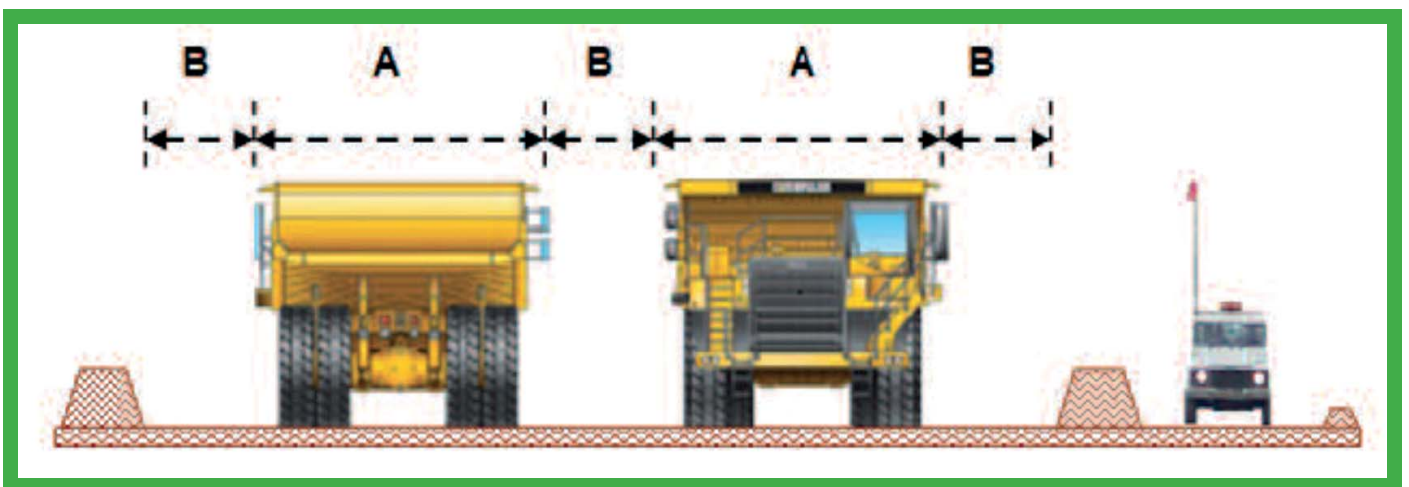

A = Width of widest truck using road
 B = Half width of widest truck
 eg. For two lane traffic - road width should be three and a half times widest truck width.



While inflating the front offside tyre of a front end loader (which was being collected from a site by a third party), the tyre mechanism ruptured and the sealing ring was ejected and struck the operator. He died of his injuries. The airline used was connected to the compressor of the truck (of the deceased) and did not have a gauge or regulator fitted.



Examples of tyre restraint systems.





Best Practice example: To eliminate the risk of over inflation of tyres, tyre pressure is inputted remotely into a control unit. The 15 metre airline is then fitted to the vehicle (away from the control unit) and a preset air pressure is used to inflate the tyre. Access to the control is restricted as users require access codes.



Introduction

There have been a number of fatal and serious accidents involving forklift trucks within the group in recent years.

Year	Fatality Details
2007	Employee struck by a reversing forklift truck
2009	Employee struck by a reversing forklift truck
2009	Employee struck by a forward moving forklift truck carrying a load
2013	Employee struck by a forward moving forklift truck

Requirements for Rule No.6

- The operational speed of the forklift must be restricted through the vehicle management system (where available) to
 - Forward speed: 16km/h
 - Reverse speed: 5 km/h

For forward and reverse movement a warning light system such as the Blue light system shown on page 53 must be considered as a possible control measure while risk assessing forklift activity within each operation (evidence of such an assessment will be required).

- A risk assessment must be carried out for each forklift to ensure that the visibility of the driver is not restricted when carrying typical/standard loads as part of the normal working shift.
- As a minimum, all forklifts must be fitted with:
 - A seat belt
 - A cabtop flashing beacon
 - A reverse warning alarm
 - A convex mirror
- All forklift drivers must carry out a documented pre start check before the commencement of their shift.
- All persons operating forklifts (including maintenance personnel who may only operate the units periodically) must receive formal training.
- Employees operating forklift trucks must receive regular refresher training. This refresher training for employees must be carried out at a minimum of **every 3 years** and must include an assessment by a competent instructor of the plant operator actually operating the item of mobile plant.

The 3 year interval for employees is to recognise the high level of risk involved with site vehicles. The refresher training does not need to be a time consuming process, it can simply involve a competent instructor observing a driver operating the vehicle for 45/60 minutes to ensure that no bad habits or poor practice have evolved since the driver's initial training.

- A "2 metre rule" applies to the operation of workplace vehicles and it is the responsibility of each driver to observe this rule. The 2 metre rule states that there must be no person within 2 metres of the vehicle, before the driver will operate the machine. A sign similar to the photo on page 53, in the relevant language, should be placed on each workplace and reach truck as a means of reminding pedestrians of the 2 metre rule.



CCTV stills of footage from a location where a van driver reversed and struck a forklift driver.



*Group Fatal Accident - Case Study 2009:
Employee struck and killed by a reversing forklift truck.*

*Reconstruction of a Serious accident – March 2015:
Worker was struck by a forward moving forklift. Driver's view was restricted by load.*



May 2009: The victim was walking towards the door when he was struck by the reversing forklift truck.

*Group Fatal Accident - Case Study:
Contract fitter struck and killed by a Forklift unit.*



Blue Spot System in operation.



2 Metre Rule displayed clearly on vehicle.



*This rule sets out the minimum requirements relating to the use of mobile phones in companies.
Some companies have introduced additional measures in relation to mobile phone use.*

Introduction

Accidents involving mobile plant account for a significant section of serious accidents in our Industry. An issue that has arisen over recent years has been the use of mobile phones by both mobile plant operators and pedestrian / workers walking in areas of traffic movement.

Year	Fatality Details
2004	Employee on a mobile phone was struck by a reversing truck
2012	Employee on a mobile phone struck by a truck moving forward

To deal with this risk, each company must implement a policy in relation to mobile phones, which as a minimum complies with the policy outline on pages 56 to 59 (a sample to assist in this process is shown on page 46).

As a minimum, each company's mobile phone policy must include:

- A requirement that the use of mobile phones in the workplace must be restricted to a minimum.
- A commitment that all company public road vehicles must be fitted with a hands free system.
- A commitment that all phone calls using the handsfree will be kept to a minimum and that the company vehicle driver will immediately inform the caller that he/she is driving.
- A clear requirement not to use mobile phones near moving machinery or near to areas where moving mobile plant is operating.
- The policy must also cover the use of a mobile phone for texting and the accessing of information through a mobile phone.

Requirements for Rule No.7

1. A Mobile Phone policy to be formulated and implemented, and as a minimum, refer to the issues highlighted in the sample policy and guides on pages 56 to 59.
2. This policy must be circulated to all employees and contractors. The policy must be incorporated into the safety induction process for employees and contractors (including all contract transport operators).
3. Site rules on the use of mobile phones must be specified in the site transport rules as required under Life Saving rule No.5.





Group Fatal Accident - Case Study 2012:

A Foreman was run over by a concrete truck which was moving forward. He became distracted after taking a mobile phone call.



Group Fatal Accident - Case Study 2004:

Foreman run over by a vehicle reversing off the weighbridge.

Mobile Phone Producers are adapting their technology to reduce the risks from the use of mobile phones. In the latest iOS 11 update from Apple, it is possible to restrict texts and emails and other notifications when the "do not disturb while driving" is activated (Automatically when connect to hands-free accessory). When the "do not disturb" is activated manually, it's only allowing incoming calls from those on a "Favourites List".

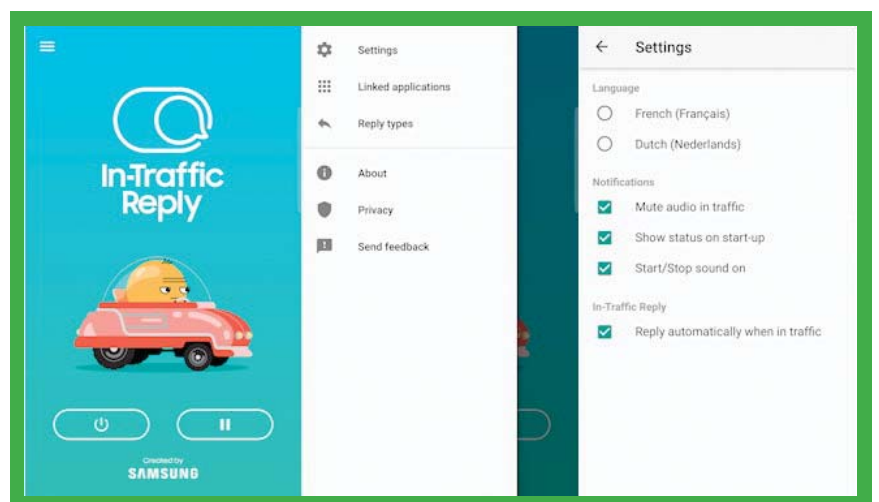

An example of mobile phone control technology for android phones is the Traffic Response app created by Samsung (for use in the Samsung Galaxy Range) the app temporarily suspends all notifications (texts, emails, social network notifications, but not calls).

Traffic Response automatically responds to incoming text and email notifications when you activate the feature on your phone. The app can also be activated to measure through the activity sensor or GPS and from 10 km/h, the app will automatically activate.

SAFE USE OF MOBILE PHONES IN THE WORKPLACE - SAMPLE POLICY

WORKSITES

TO SITE MANAGERS / SUPERVISORS / ALL STAFF SUBCONTRACTORS:

The Use of Personal Phones for personal calls or personal messages should be restricted to break times. Any employee who needs to make/receive an urgent personal telephone call will be accommodated – please ask your Supervisor.

Where Possible, machine operators and those working near fixed plant/machinery should avoid the use of mobile phones.

DO NOT

- DO NOT Answer a call when operating Plant and/or Machinery.
- DO NOT Answer a call if communicating with others on site radios. e.g. slinger/banksman / crane drivers.
- DO NOT Use or operate a phone when climbing a ladder or other similar structures.
- DO NOT Operate mobile phones or other electrical equipment near petrol containers or other flammable substances.
- DO NOT Permit the use of mobile phones when excavating near gas pipelines.
- DO NOT Use mobile phones in areas where the site rules strictly forbid them.
- DO NOT Operate mobile phones when crossing traffic routes.
- DO NOT Operate mobile phones near any shot-firing operations.

DO

- Carry a mobile phone if working alone in a remote area e.g. driller.
- Carry a mobile phone if you are concerned about your safety going to or from work.
- Ensure you have quick and effective communications available for emergency situations.
- Ensure you are standing in a safe area before answering a call.

Mobile Phone Safety Guidance

Why are we introducing this guidance on mobile phones?

The objective of this policy is to provide a structure on the use of mobile phones to those using phones in vehicles within our business during the course of their work. The core objective of this new guidance is to bring about the following changes:

- To eliminate the behaviour of people using phone handsets to read emails, read or send texts or to access web sites.
- To help us all to assess our driving environment before using the hands free phone system.
- To move us all towards the use of the voice activation features on our phone systems.
- To help us to consider the fact that some people who we may be calling in the course of our work may be driving.

If we achieve these objectives with this new guidance, then this will represent a significant improvement in the risk management in this area.

Introduction

1. Mobile phones are a significant element of everyday communication and once used safely they present a very efficient communication tool for employees. The challenge with developing a safety policy in relation to mobile phone use is the need to try and allow employees to get the benefit of such a tool, but in such a way that the phone is used in a safe and controlled manner. The monitoring of compliance with this requirement will be very difficult, hence the focus on education and training as part of this overall program. The amended LSR No.7 of the 16LSR covers the issue of mobile phone use by all employees when on company business, in the company, owned (by the employee on company business) or rented vehicles.

Other points to note:

- This recommendation represents minimum standards. Companies can go beyond the recommendation if required, i.e have additional controls.
- The use of a mobile phone to review, read or send emails or texts while operating a vehicle is strictly prohibited.



Mobile Phone Safety Guidance

2. Company, owned, leased or rented cars.

Key elements for mobile phone use in company, owned (on company business), leased or rented cars. (vehicles over 3.5t or over are covered in section 3).

To allow time for policy communication and awareness training through the CRH campaign - the car mobile phone policy should be fully rolled out by January 1st 2019

- 2.1. To support the proposed changes, a significant internal campaign entitled "Mobile Phone - Responsible use" will be developed and launched across CRH Europe in Q2 2018. This will be a campaign incorporating explanation around the new policy, practical guidance on the safe use of mobile phones and personal testimonies from car accident victims where mobile phone use was a factor.

The campaign will also highlight the features which are now being added to phones to control and restrict mobile phone use while driving (see the example of the latest iPhone and Android approaches on page 55).

- 2.2. Key elements of the amended rule on mobile phone use and the "Mobile Phone- Responsible Use" program:

- 2.2.1. On completion of the program, each participant will sign a pledge undertaking to follow the key aspects of the requirements as outlined below. It should be noted that failure to comply with this program will result in disciplinary action.

- 2.2.2. The Handset cannot be used for any purpose* related to texting, emails, or any form of web use. All handsets should, where possible, be out of reach before a car journey starts. Where the technology is available on your phone (iPhone or Android) it must be activated immediately.

**An exception is permitted if the phone is used for satellite navigation purposes. In such a case the phone must be mounted in a fixed device where it can be easily seen while keeping a good view of the road, it must not obstruct the driver's view and cannot be held in the hand. The driver is not allowed to manipulate the device while driving.*



Mobile Phone Safety Guidance



- 2.3. Drivers can receive hands free phone calls once they undertake to:
- 2.3.1. Immediately inform the caller that they are driving.
 - 2.3.2. Keep the call duration to an absolute minimum. If a conversation is unlikely to be short, the caller must be told they will be contacted as soon as the driver has found a safe place to park.
 - 2.3.3. Not to take a call when driving in an unfamiliar environment. Even in familiar areas, the awareness program (Mobile Phone-Responsible Use) will feature practical examples to focus on the need for drivers to continue to assess the overall situation, which includes other traffic, pedestrians, visibility and the weather/elements at the time.
- Please note, a driver is under no obligation to answer or make a call (using the hands free system) while operating the vehicle.
- 2.4. Drivers can make hands free mobile phone calls once they undertake to:
- 2.4.1. Only use voice activation to activate the call (or an integrated steering wheel system which allows the driver to keep their hands on the steering wheel and their eyes on the road).
 - Voice activation is a safety feature on most phones, yet is not used by the vast majority of phone users. This program would require all employees using vehicles for company business to introduce and manage this feature.
 - 2.4.2. To only initiate a call when driving in a familiar environment. Practical examples or how to assess the environment will be featured in the “Mobile Phone-Responsible Use” campaign.
 - 2.4.3. To keep such calls to a minimum - the “Responsible Use” program would allow an element of professional discretion in terms of making calls, but would envisage that only calls related to schedule issues (running late), business critical issues (a short update on plant breakdown or urgent short commercial update). It is envisaged that such calls should last no longer than a few minutes.
- 2.5. As a general principle under the “Mobile Phone-Responsible Use” program and related training:
- 2.5.1. All CRH personnel who make a work related call to a mobile phone, would be required to first ask the person they are calling if they are driving and if it is safe to take the call. If the person being called is driving and where the call is not urgent, the CRH caller has a responsibility to end the call as soon as possible.
 - 2.5.2. Where a CRH employee makes a call to the mobile phone of a colleague, and that colleague is driving, the conversation should be brief. If the call relates to anything that may be contentious or require significant discussion/debate then the responsibility is on the caller to avoid and defer such a conversation.

Mobile Phone Safety Guidance



3. Vehicles over 3.5t

The challenges posed to the drivers of such vehicles is significantly ahead of those faced by other vehicle drivers. As a result the mobile phone policy applying to this category of drivers needs to allow much less discretion than for smaller vehicles.

While the requirements listed here are new and may initially be received negatively, it is important to remember that any additional unnecessary burden on the concentration and focus of a Heavy Goods Vehicle driver, is not acceptable. These changes will bring about a gradual change of culture in relation to the use of mobile phones.

For drivers of vehicles over 3.5t.

- 3.1. The Handset cannot be used for any purpose* related to texting or emails. All handsets should where possible, be out of reach before a journey starts.

**An exception is permitted if the phone is used for satellite navigation purposes. In such a case the phone must be mounted in a fixed device where it can be easily seen while keeping a good view of the road, it must not obstruct the driver's view and cannot be held in the hand. The driver is not allowed to manipulate the device while driving.*

- 3.2. Drivers are not permitted to make hands free phone calls while driving. The only exceptions are in the event of an emergency or to request assistance in the event of a breakdown. One exception is permitted, where a driver needs to contact a customer to provide an accurate arrival time. This is permitted under two conditions:
 1. The customer number is programmed into the phone in advance of the journey.
 2. The call is kept to an absolute minimum.

Note. A number of companies now have integrated EPS Monitoring of delivery vehicle locations. These systems should be used as much as possible to reduce the need for drivers to contact anyone.

Mobile Phone Safety Guidance

- 3.3. Drivers are permitted to take hands free phone calls while driving only under the following conditions.
- 3.3.1. The call relates to an urgent issue relating the delivery and it is safe to do so*. There is an onus on each driver to ensure key phone numbers (which are related to the delivery e.g the CRH weighbridge) are identifiable so the driver can recognise all calls that come through to the driver's phone.
- *Not to take a call when driving in an unfamiliar environment. Even in familiar areas, the awareness program (Mobile Phone-Responsible Use) will feature practical examples to focus on the need for drivers to continue to assess the overall situation, which includes other traffic, pedestrians, visibility and the weather/elements at the time.*
- 3.3.2. The call is taken without using the handset, for example by using the steering wheel mounted controls.
- 3.3.3. The call must be kept to an absolute minimum (to receive an additional instruction or to report on current location). A driver is under no obligation to answer a call (using the hands free system) while operating the vehicle.
- 3.4. There is an additional professional and personal responsibility on all CRH personnel who as part of their roles may be required to call Heavy Goods Vehicle drivers. This applies in particular to weighbridge personnel and sales staff. Such staff have a responsibility to ask before each call:
- Is this call necessary?
 - Should I allow some additional time before I make that call (if a customer is waiting on delivery).
- Once the call is made, such staff have a very significant responsibility to keep the call to an absolute minimum (a matter of seconds). Practical examples will be featured in the " Mobile Phone-Responsible Use" campaign.

To allow time for training and communication - the policy should be fully rolled out by April 2019 (due to the significant number of contractors involved, additional time is being allowed for this communication program).



Make the glove compartment the phone compartment.

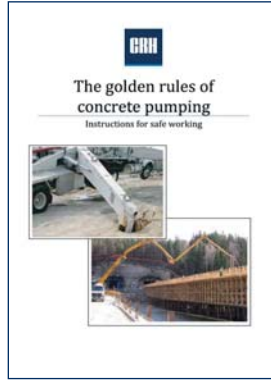
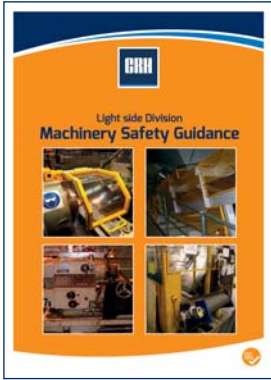

Introduction

A significant section of the working population within our operations are employee and contract drivers of public road HGV's (Heavy Goods Vehicles) transporting material on our behalf. While we cannot monitor and check every aspect of contract haulier safety and behaviour, we must have in place a system that ensures that each contractor transport company is aware of our safety requirements and that we have a system that monitors the implementation of these requirements by the transport contractor.

Drivers who are involved in the delivery and erection of precast elements are also covered by Life Saving Rule No.11.

The key elements of any such system relating to the management of contract public road transport contractors must cover the following:

- Screening drivers - in practice undertaking background screening checks on drivers to verify their driving records.
- Driver training programs.
- Monitoring driver fitness for work.
- Vehicle standards.
- Providing facilities to enable drivers to comply with company rules - rest areas etc.
- Journey management planning (in certain countries).

It is important to note that these requirements do not apply to:

- Vehicles coming on site to collect on behalf of a customer.
- Vehicles delivering goods or products from an outside source e.g fly-ash, welding equipment etc.
- Courier companies.

It is essential that:

a) A formal system is in place to ensure that all such contract drivers have received formal induction safety training for the type of work they will be conducting. This training should include a detailed section on the hazards of:

- Overhead electrical power lines.
- The precautions required while tipping a load. This particular aspect of contract transport activity represents a significant number of high potential learning events.
- Requirement for Personal Protective Equipment (PPE).
- Site safety requirements relating to the CRH site that they are collecting material from.
- The issues to be covered in a vehicle pre start check (prestart checks must be documented).
- Where partial or mixed loads are a feature of the work carried out for CRH, the contract transport company must have training programs that cover details considerations for securing / strapping loads.
- The CRH policy on mobile phone use and the requirement for a hands free system only.

The key requirement here is that contract transport companies working on our behalf must maintain records confirming that their drivers have received this training. From time to time the CRH company must carry out random checks on the implementation of the CRH safety requirements within that company.

In summary we are requiring contract transport companies working on our behalf to train their drivers on the issues highlighted above. In many cases the CRH company may assist the contract transport company in this process by providing training material such as DVD's etc. In some cases, where regular contract transport companies are used on a long term basis the CRH company may decide to carry out some of the training requirements.

b) Each transport company working on our behalf has a system in place to ensure all of their drivers have a valid driving licence to drive/operate the particular class of vehicle. The CRH company must have a system to periodically check the implementation of such a system among it's contract transport companies.

The requirements of a) and b) above need to be included as part of a prequalification process.

Requirements for Rule No.8

1. All transport companies (operating public road vehicles) operating on behalf of a CRH company must have a formal safety awareness training program which as a minimum covers the issues in a) above. Each CRH company must have a system to periodically check the **implementation** of such a program among their contract transport companies.
2. Each transport company operating on our behalf must have an internal database (a basic record system will suffice for smaller contractors) which records the licence details for each of their drivers and the insurance details for each of their vehicles (which could operate on behalf of CRH).

Each CRH company must have a system to periodically check the **implementation** of such a database among their contract transport companies and

3. All drivers operating for a contract transport company must carry out **documented** daily pre-use vehicle check.

As a minimum this prestart check must include:

- A visual inspection of each vehicle tyre.
- The condition and position of vehicle mirrors (including the pedestrian safety mirror).
- That all vehicle lights are operational.
- That the reversing warning system is operational.

The requirement is for the CRH company to check that a documented prestart check has been carried out, the CRH company does not have to carry out that check.

4. Where partial or mixed loads are a feature of the work carried out for CRH, the contract transport company must have training programs that cover details considerations for securing / strapping loads.
5. From March 1st 2018, all Heavy Goods Vehicles working for CRH will be required to have the following safety devices fitted:
 - An audible alarm which warns the driver that the handbrake is not applied when the cab door is opened.
 - To have side under run protection guards with combined pedestrian/cyclist warning sign (see photo on Page 66).
 - All rigid heavy goods vehicles (aggregate tipper trucks and RMC mixers), either contract or owned must be fitted with a CCTV or radar system to assist with reversing.
 - All owned articulated vehicles must be fitted with a CCTV or radar system to assist with reversing.
6. From June 1st 2017, all new contracts signed with Contract Transport Companies must include a safety section as outlined on page 67.
7. The Site Truck Driver Induction must include an assessment. An online safety induction prior to the driver coming to the site is permitted.



Pedestrian Safety Mirror a CRH requirement.

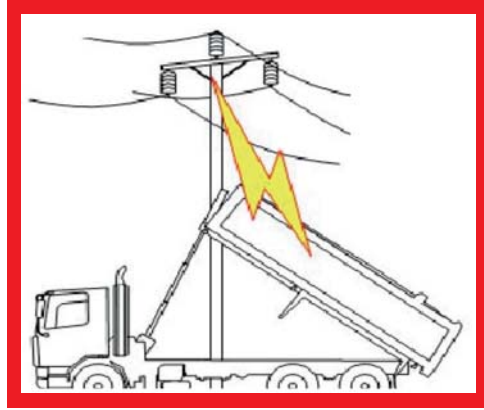

Danger from overhead power lines must be covered in the Haulier Induction.



Pre start check book for truck operator.

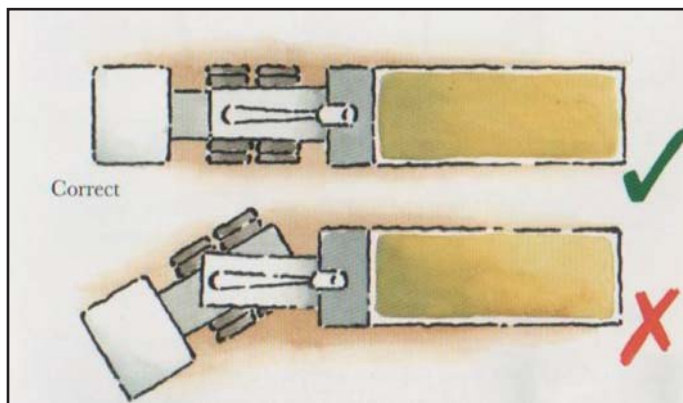
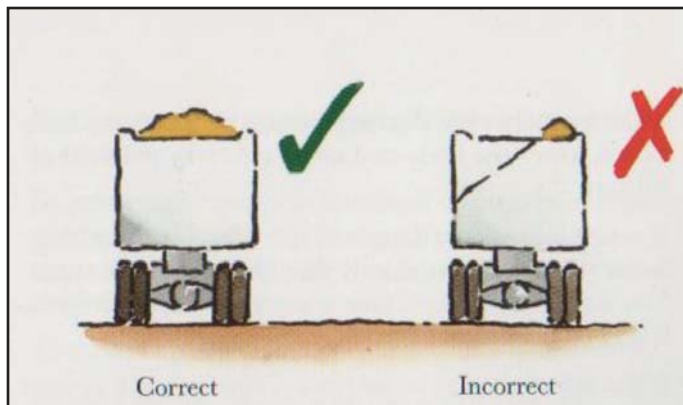
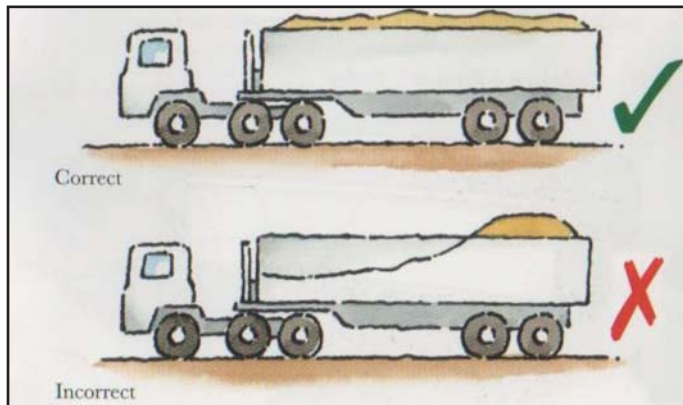

Safe loading and unloading rules must be covered in the Haulier Induction.



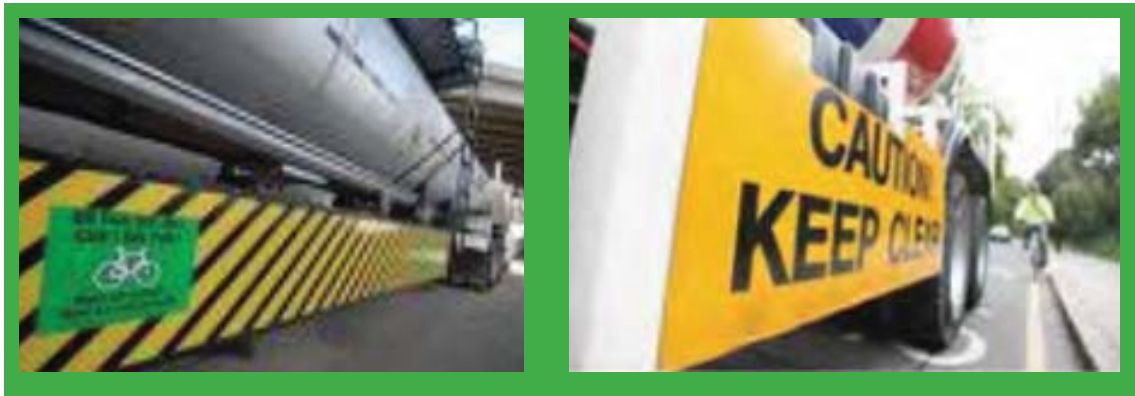

Side protection warnings



Safety Element/Addition to Contracts

A transport contractor for CRH shall on signing the contract agree to the following requirements:

- 1.1. Must pass an initial safety prequalification process in accordance with the relevant operating company procedures.
- 1.2. Must comply with CRH driver and vehicle safety requirements and the key aspects covered in the “ CRH Transport Safety Checks “ which cover verification of the following:
 1. That the driver of the contract vehicle has conducted a daily prestart check of the vehicle before the commencement of his shift.
 2. That the driver has the required personal protective equipment in the vehicle.
 3. That the reverse warning system (a reverse alarm and a CCTV * (or similar detection system)) is in working order.
 4. That a pedestrian mirror is fitted to the front windscreen of the vehicle.
 5. That a handbrake warning alarm is in place where if the driver door is opened an alarm will sound if the handbrake is not engaged.*
 6. To have side under run protection guards with combined pedestrian/cyclist warning signs.*
 7. Load security (where applicable).

* required by March 2018

- 1.3. All vehicles purchased by the Transport Contractor after the date of this contract are expected to comply with the safety specifications outlined in relevant heavy goods vehicle section the CRH Red Book (guidance on procurement).
- 1.4. If the Transport contractor fails to pass any element of the CRH Transport Safety Check – they shall be liable to a sanction. The system of sanction will be decided by the opco.

Example

- Failure of a CRH Transport Safety Check: €100 (and dismissal from site if non-compliance is deemed by local management to be serious).

- 1.5. Additional sanctions, as defined by the opco may also be put in place.
- 1.6. The Transport Contractor will be required to be attend and participate in ongoing Driver health initiatives.



There are a wide range of project activities across the CRH group which come under the category of construction project. Such projects can range from the large undertakings such as the construction of cement plants (which can cost in the region of €250m), lime works, captive power plants and waste heat recovery plants to the installation/dismantling of a concrete plant.

Due to the scale of the activity on a construction project including the quantity and diverse nature of contractors/contractor work present, such projects carry a very significant risk of serious injury.

Such projects require considerable levels of planning and risk management in addition to significant levels of co-ordination of both processes and contractors.

To counter this risk, all construction projects within this division must comply with:

1. The CRH Construction Project Protocol

This document covers the key aspects of:

- Project Management structures: Safety.
- Project Planning: Design (Safety).
- Contractor Management.
- Project safety plan development and implementation.

2. The CRH Construction Project Safety Manual

- This document covers the technical safety requirements that all designers and construction contractors must comply with:

Construction Project Definition

Projects for the purposes of this protocol are defined as:

- A greenfield development of a:
 - Greenfield development of an aggregate location
 - Cement manufacturing process
 - Cement grinding process
 - Installation/ preassembly of a Concrete Plant
 - Addition/extension to a concrete products facility
 - Concrete Products plant e.g precast plant
 - Lime
 - A lightside fabrication/assembly facility
 - Asphalt plant
 - Any other development deemed by the management team as a significant project
- Brownfield (refurbishment) development (or dismantling) of:
 - New cement manufacturing line
 - Captive Power Plant
 - Waste heat recovery plant

As with previous projects, CRH personnel can be integrated into the project management structure as deemed appropriate by CRH.

It is the responsibility of the manager responsible for the project to ensure that the protocol and safety manual requirements are assessed at the project planning stage.

Requirements for Rule No.9

All construction projects (major and non major) within this division must comply with:

- The CRH Construction Project Protocol.
- The CRH Construction Project Safety Manual.



*Fatal Accident 2011:
Contractor fell while crossing a wall during the construction of an extension.*



Safety Netting in place.



Transport systems at a construction site.



Raw Meal Silo Project.



Trench Boxes in use.

Introduction

Road surfacing / maintenance / repair is a significant activity within a number of our businesses. In addition to the hazards within the work site of moving vehicles, machinery and the handling of hot material, the additional very significant hazard of working close to live/moving public road traffic requires specific risk control measures.



Requirements for Rule No.10

Each work project/job must have a specific risk assessment, which as a minimum must cover the following:

1. Control Reversing Vehicles

- HGV delivery or collection vehicles must be instructed not to reverse unless they are under the direct control of a banksman/approved traffic controller.
- The banksman/approved traffic controller must be identified by wearing the designated orange jacket or vest with the word 'Banksman/Approved Traffic Controller' on the back.
- All vehicles delivering aggregates, asphalt or concrete must be fitted with:
 - i. A working CCTV rear view camera
 - ii. Audible reverse warning alarm
 - iii. White reversing lights
 - iv. Amber rotating beacon(s)

2. Mobile Plant Safety Zones

- All mobile plant/vehicle drivers must maintain a safety zone (in the path of travel) between the item of mobile plant/vehicle that they are driving and any pedestrian.
- The safety zones are:
 - 5 metres in the direct line of travel of any vehicle or item of plant.
 - 20 metres for mechanical road sweepers in the direct line of travel. You are allowed access to the paver augers only for the purpose of hand shovelling, testing or back casting of material.

3. Overhead Services

- Work adjacent to overhead service must only be carried out following the completion of a specific risk assessment and the development of a job specific safe system of work.

4. Buried Services (Underground Cables)

- Excavation work must only be carried out following the completion of a survey for buried services and the development of a job specific safe system of work.
- Procedures must be in place to ensure protection of workers against the risk of engulfment while working in the excavation and the risk of falling while working around the excavation.

5. Traffic Management

- Each project/job must have a specifically designed traffic management system based on a risk assessment. In addition to the issues around live traffic control, each traffic management system must include pedestrian management controls.





Road-surfacing at night close to live traffic.



Checking for the presence of underground services prior to the erection of fencing.

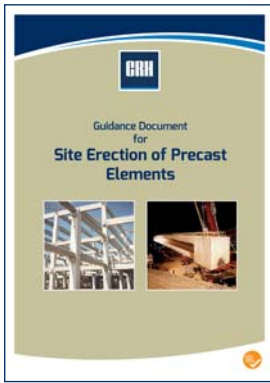

Introduction

There have been a number of serious accidents within the division which have occurred during lifting operations. Such operations have often involved the use of mobile cranes and the use of gantry cranes within operations.

A summary of these accidents is as follows:

Year	Fatality Details
1997	Contractor crushed when load fell from crane
1997	Contractor struck when a frame being lifted fell on him
2005	Contractor fell from a walkway while supervising a lifting operation being carried out by a crane when the walkway he was standing was undermined and collapsed
2008	Employee, a crane operator was killed when a precast wall panel she was moving fell and she was crushed
2009	Contractor struck by a glass element which was being lifted when the special vacuum lifting system malfunctioned
2009	Contractor struck by a beam which had fallen after being struck accidentally by a crane
2010	Employee lifting a concrete panel from a mould onto a transport car using a bridge crane when the lifting attachment on the mould failed and fell
2017	Employee killed after standing moulds fell when the concrete bucket he was moving with a Gantry Crane struck the moulds

Requirements for Rule 11

- Each company must have a system in place to ensure that in the prequalification of contractors who will be involved in lifting operations includes the verification of lifting equipment certification (See also LSR No.1).
- Each company must have a system in place to ensure all operators of lifting equipment - static or mobile - must be trained in the operation of the equipment. A training program must also be in place for those responsible for securing loads for lifting.
 - Training for operators of gantry cranes must include an assessment of work on the work (CRH) site, this is to ensure that the assessment covers the lifting work that the trainee will actually be carrying out rather than off site training only with other lifting scenarios.
 - Supervisors whose area of responsibility covers areas where lifting is carried out must also receive training in the Lifting operation safety. Specifically from September 2018, all supervisors in precast and paving operations, whose area of responsibility covers work areas where gantry cranes are used, must also receive certification as a gantry crane operator.
 - Refresher training must be carried out every 3 years.
- Each company must have a system in place to ensure that the risk assessment for lifting operations covers checks on personnel competency, equipment certification and loading rates in accordance with a defined location specific policy.
- All slings and chains in use must have a rated capacity tag (with id number) and evidence of last inspection on the sling or chain.
- All gantry crane controls must be labelled. A system of inspections to ensure the controls are labelled must also be in place.

Requirements for Rule 11 (cont.)

6. All gantry crane controls must be risk assessed for the possibility of inadvertent contact by the operator with the controls. As a minimum this will involve a barrier around the control to prevent inadvertent contact with the crane joystick - see photograph on page 76.
7. All lifting hooks must be fitted with safety latches.
8. Each company must have a system in place to ensure the regular inspection of:
 - Hoisting ropes
 - Load hooks
 - Limit switches
 - Brakes
 - Hoisting
 - Bridge
 - Trolley
 - Straps
 - Chains
 - Lifting Accessories
 - Alarms
 - All other safety features
9. In operations where cranes are operating, exclusion zones (for personnel not involved in lifting operations) must be clearly identified and established.
10. Inserts embedded in the concrete product shall be designed for an ultimate load that is 4 times the working load (Factor Safety of 4) or as per national standards/requirements.
11. Material being moved into storage should be stored in a securing mechanism similar to the photographs at the bottom of page 77.
12. Site Erection:
 - Every company involved in site erection activities must have a construction site guidance manual, covering erection issues. A sample is provided.
 - Every construction site must have a specific plan for curing/stiffening during construction time, including clear rules for curing times and the withdrawal of structural supports.
 - There must be a start-up meeting with all involved staff, to ensure correct handling, stiffening, dismantling, use of fall protection, use of scaffolds, PPE safe areas for crane use, site transport roads and other relevant items.
 - There must be clear guidelines for any adjustments to the proposed construction methods or processes.
13. At sites where lifting equipment is used, a colour coding system should be put in place, which allows a person to see if that item of lifting equipment has been inspected as per the requirements for that piece of equipment. See examples on page 75.

YOUR LOGO
HERE

**LIFTING EQUIPMENT
FOR THE PERIOD**

Dry wipe date box

TO

Dry wipe date box

**ONLY EQUIPMENT
COLOURED**

**TO BE USED BY
TRAINED PERSONNEL**

QS10 is designed to show which lifting equipment is safe tested for current use. Made in weather proof steel and is supplied with Coloured Magnetic Panels

RED

BLUE

GREEN

YELLOW



**THE CURRENT
CHAIN / SLING COLOUR
CODE IS RED
DO NOT USE ANY
LIFTING EQUIPMENT NOT
MARKED THIS COLOUR**

GREEN

RED

BLUE

YELLOW



*Group Fatal Accident - Case Study 2005:
Contractor fell from walkway as it was being lifted.*



*Group Fatal Accident - Case Study 2006:
During a lifting operation, a supervisor was trapped
between the load being lifted and a steel beam.*



Dead Mans Joystick. You must push down to activate the joystick.



October 19th 2017:

A crane operator using a remote control system was fatally injured when a concrete bucket (top of photo) he was moving struck wall panel moulds. The moulds fell on him causing fatal injuries.





Typical lifting scenarios.



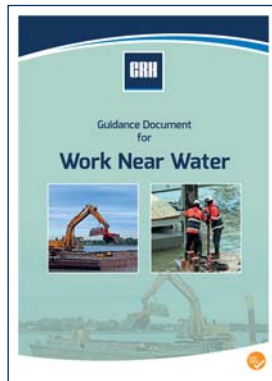
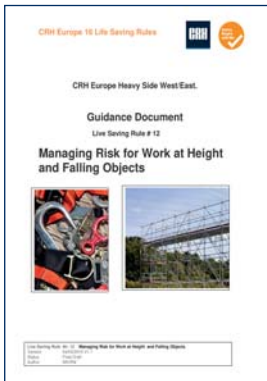

Introduction

Falls from height and falling objects have accounted for a number of fatal accidents across the group in recent years. Fatalities within the group relating to work at height and falling objects can be summarised as follows:

Year	Fatality Details
1997	Employee crushed when load fell from crane
2000	Contractor fell through opening in roof
2000	Contract driller fell from quarry face
2002	Contractor fell through opening in roof
2002	Employee fell through chute opening
2002	Contractor fell through roof sheeting while repairing smoke vents
2003	Contractor fell from silo while painting it
2004	Employee fell from first floor in storage area
2005	Contractor fell 10 metres while involved dismantling a walkway
2006	Employee fell 5 metres through an unprotected opening in the floor
2007	Manager fell through a steel section of walkway which gave way when he stood on it
2008	Employee fell from a walkway while trying to re-align a conveyor belt
2008	Contractor was descending from a work platform when he unclipped his safety harness, he fell while descending an access ladder
2009	Contractor entered a restricted area and fell through a section of walkway flooring which had been removed
2013	Contractor fell from height during mill repair
2014	Employee drowned while he fell from boat during maintenance work
2017	Contractor killed when load fell from truck onto him
2017	Employee fell 3 metres from a pallet loading area in distribution location

This rule focuses on five risk control strategies for this particular hazard:

- a) The full time presence of a leased/hired/purchased MEWP (Mobile elevating work platform) or “Cherry Picker” on site, where the scale of operation warrants the presence of such a vehicle (Company Safety personnel can determine the need based on a risk assessment).
- b) The installation of man grids on all hopper/bin openings, where there is a risk that a person may fall into that structure.
- c) As a last line of defence, safety nets should be used during the construction/demolition / modification of plant or buildings (in addition to having a MEWP available). The installation of the nets should only be carried out by a competent contractor.
- d) The risk to those working on the quarry top (Drilling and Blasting operations) from falling over the edge is eliminated through the use of a barrier system or bund (see photo on page 86). It is important that a safety harness / lanyard is also provided to deal with a situation where a person may have to go in front of the barrier.
- e) The use of ladders at any operations:
 - Should be kept to a minimum.
 - Should be restricted i.e not accessible. This will involve controlling access to ladders.
 - Their use should be subject to a visual inspection before use.

Risk assessments relating to work at height must now address the 5 key risk control measures outlined above.

Requirements for Rule No.12

1. The risk assessments for each location within each company should include an assessment for the presence on a full time basis of a MEWP (purchased or leased).
2. An inspection system for all safety harnesses and associated accessories must be in place at each operation. Where a person working at height needs to move such that he needs to attach and re-attach from an anchor point, then a double leg lanyard shall be used - see photos on page 82.
3. Man grids should be fitted to all hopper and bin openings where there is a risk of a person falling into such an opening. Maintaining “full bins” is not adequate.
4. A policy relating to the use of ladders should be in place covering the issues outlined on the previous page.
5. Where deemed appropriate, safety nets should be used as a means of reducing the risk of injuries involving falls from height during construction /modification/maintenance work.
6. Systems for work on the quarry top, such as barrier systems or bunds (see photographs on next page), must operate to a site specific safe system of work. A safe system of work for the installation / removal of any barrier / protective system. See photo on page 86.
7. All locations must carry out a Risk Assessment related to working at heights and document location-specific risks and control measures. This risk assessment must cover the issue of emergencies and the need to rescue a person working at height, e.g a person who has fallen while attached to a lanyard or who has fallen into a safety net. (Please note in many cases, the use of the local emergency services, once assessed as being likely to react in a timely fashion, may be a sufficient control).

Requirements for Rule 12 (cont.)

8. Where material is being lifted overhead or where machinery is moving overhead and/or where there is a risk of:
- Material falling downwards from a manufacturing process onto an area where people may be present.
 - Storage material falling sideways onto a person's head.
 - Products being loaded falling from the loading vehicle such as a forklift.

Then the use of safety helmets must be a requirement at that operation.

9. Specific training must be given to all relevant employees relating to working at heights.
10. In some of our operations where the risk of a fall from height may be high, one possible element of the risk control strategy is the use of straps on helmets (see photograph on page 86). In situations where a person falls a short distance backwards or forwards, the level of injury from striking against a structure may be reduced if the helmet stays in position on the person. The need for straps to be used with helmets, for work at height or while working in certain areas, should be assessed annually.
11. Storage and Racks:
- Racks must be installed and maintained according to ISO 15635. When racks are adjusted or modifications are made, there must be a new inspection by a competent person.
 - Procedures for securing and preventing storage material from falling must be in place at each location.
 - A system must be in place to ensure all damage must be reported immediately to the location manager / nominated person.
 - All racks must be annually inspected by a competent and certified person (internal or external).
 - When racks are adjusted or modified, then there must be a new inspection by a competent person (internal or external).
 - Procedures for securing and preventing storage material from falling must be in place at each location. These procedures must include a requirement that material stored at a height of over 2 metres, over the storage area floor level must be secured (plastic wrapped or strapped). The following are minimum requirements:
 - Corner protection (Does not include cantilever racks).
 - Corner protection is mandatory on corners where motorized site transport / mobile plant are in use.
 - Securing pins
 - All beams must be secured with the official securing pin from supplier.
 - Floor Fixing
 - Floor Fixing is mandatory for every new-build or replaced racking and is advised for current racks.
 - A system of procedures and signs must be in place to ensure all damage to racking must be reported immediately to the location manager / responsible person.
 - Key technical requirements are outlined on pages 90 and 91.
 - All staff involved in the placing of pallets on racking must receive formal instruction on the key elements of EN 15620 in relation to clearance distances between pallets.
 - Storage racks should be labelled with maximum storage capacity.
12. From 2017, a barrier system, in the adjustable form (see photograph on page 87) must be in place to protect persons having to access the top of cement tanker vehicles for loading purposes.
13. All areas on elevated floors, used for loading and unloading of products should have a revolving cage system or similar in place to prevent the risk of falling. See photo on page 85.

Requirements for Rule 12 (cont.)**14. Working near water.**

Work near water is defined as work where pedestrians may have to work within 2 metres of water or vehicles may have to work within 4 metres of water where the water depth is in excess of 1 metre.

In the case of work near water – each operation where this may apply must have system to cover risk assessment, work practices, PPE and training. A guidance document on work near water is available to offer specific guidance on each of these key points.

15. Grids and flooring on walkways must be fixed by clamps and inspected at least annually by a competent internal person. See accident details on page 83.**16. As a non primary control measure to prevent foot injury from falling objects, locations must introduce a type of safety boot which provides metatarsal protection. This is a form of safety shoe which provides full protection to the front of the foot, not just the area of the foot covered by the traditional toe cap protection safety shoe. This type of safety footwear must be in place from January 1st 2018 (see page 87). An exception to this rule only applies where a risk assessment prepared by an internal safety professional allows the non use of this type of safety shoe. The metatarsal shoe/boot to be used must be the integrated type where the metatarsal protection is part of the boot/shoe. The type of metatarsal shoe/boot with an attached flap which is over the shoe/boot is not acceptable as it may present a hazard where people are accessing stairs or using access ladders.****17. At sites where drivers are required to gain access to the body of the truck body, systems must be in place to reduce the need for such access (onto the truck of the body) or to assist in tasks which require such access. Suitable access platforms are highlighted on pages 92 and 93.****18. There have been a number of incidents in previous years of young persons gaining access, without authorisation, to sites where there are water areas (see page 94). The purpose of such unauthorised access, which usually occurs during summer/school holiday periods, is to use this water areas for swimming purposes. Each site is required to conduct a risk assessment which assesses the risk of trespass onto the site, a guidance note “Tackling Teenage Trespass” is available to assist in the preparation of such assessments. See page 5.**

Harness Lanyard



Additional securing hooks for harness use - installed where required.



Fatal Accident 2011:

Construction Project: contractor fell while crossing a wall during the construction of an extension.



Group Fatal Accident - Case Study 2008:

Contractor fell from upper level while descending. Risk assessment identified the need for a MEWP (Mobile Elevating Work Platform), but none was used.



Fatal accident (non CRH site):

Worker fell 14 metres when a section of walkway grid gave way. The grid securing bolts had become loose, over a period of time, due to the nearby vibrating screen.

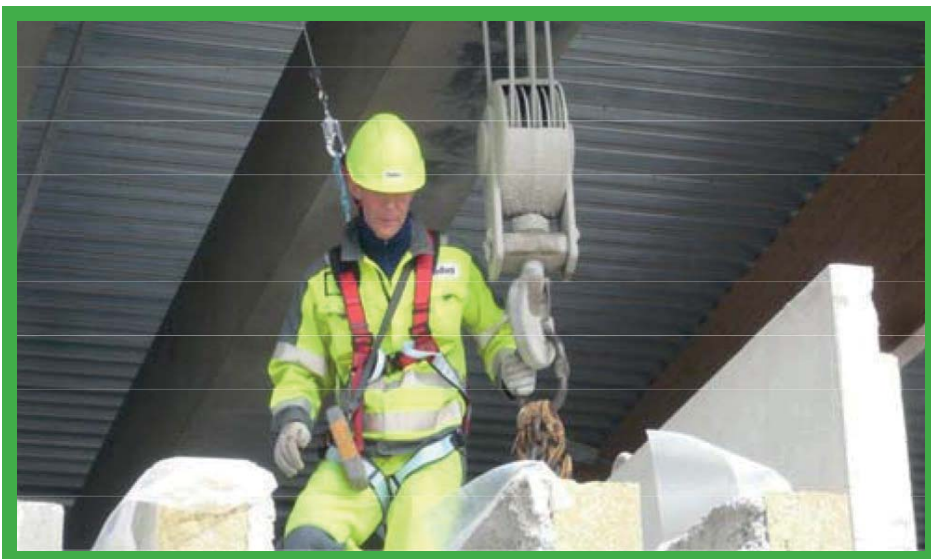
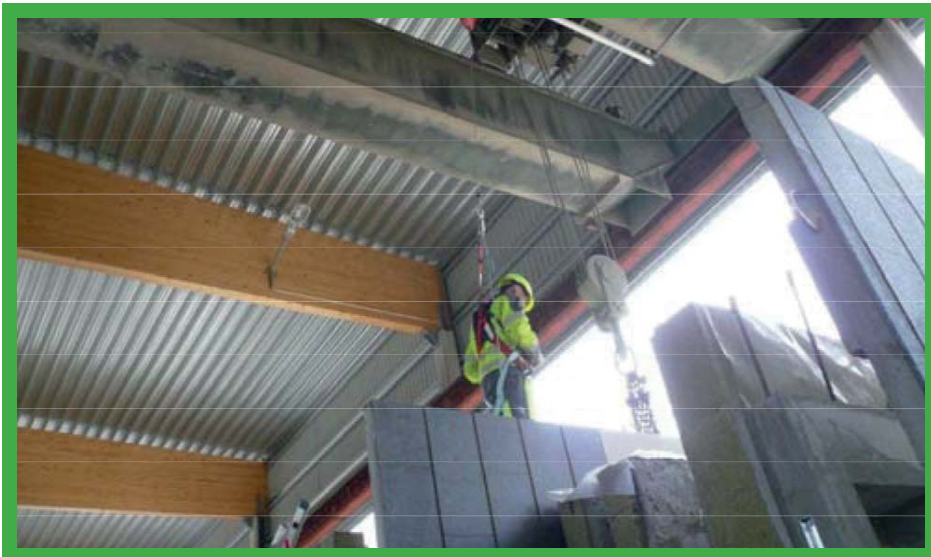

Safe access system for securing and detaching lifting slings



Safe access for attaching lifting hooks.



MEWP's in operation in brick manufacturing and cement production.



March 25th 2017:

Employee loaded a pallet into the unloading area on the 1st floor. When trying to secure some of the material on the pallet, he suffered a medical event and fell over the unguarded edge.



A revolving cage system which offers protection against falls.



Barrier system at quarry face.



Use of material bunds at the quarry face.



Man grids in place.



Safety Nets in use.



System at Finnsementti to protect the tanker driver during loading. This system has to be adjusted in terms of length and height to cover all vehicle sizes.



August 2017 accident: contractor suffered serious foot injury after blocks landed on area behind the steel toe cap shoe and struck the area that would have been covered by a metatarsal shoe or boot.



A Meta Tarsal Boot.



A Meta Tarsal Shoe and boot.





3 supporting beams for storage pallets.



Securing Pins - missing.

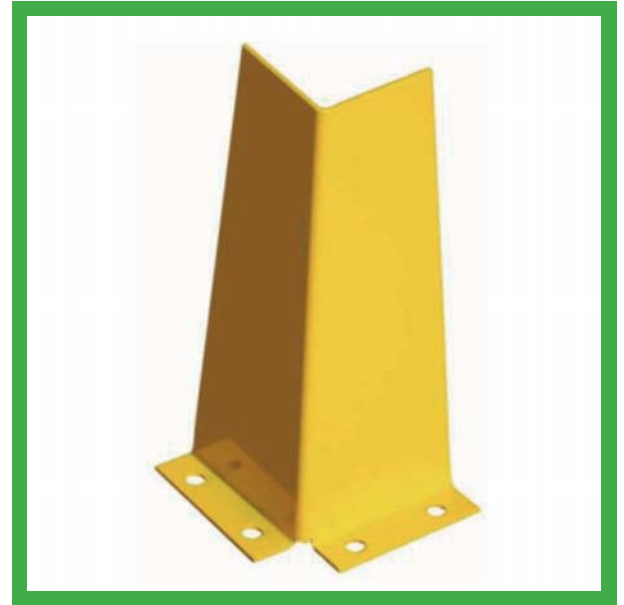

Corner Protection - mandatory.



Securing Pins - wrong kind.



Floor Fixings - broken or missing.

Racking Safety

Maximum Deflection on Racks

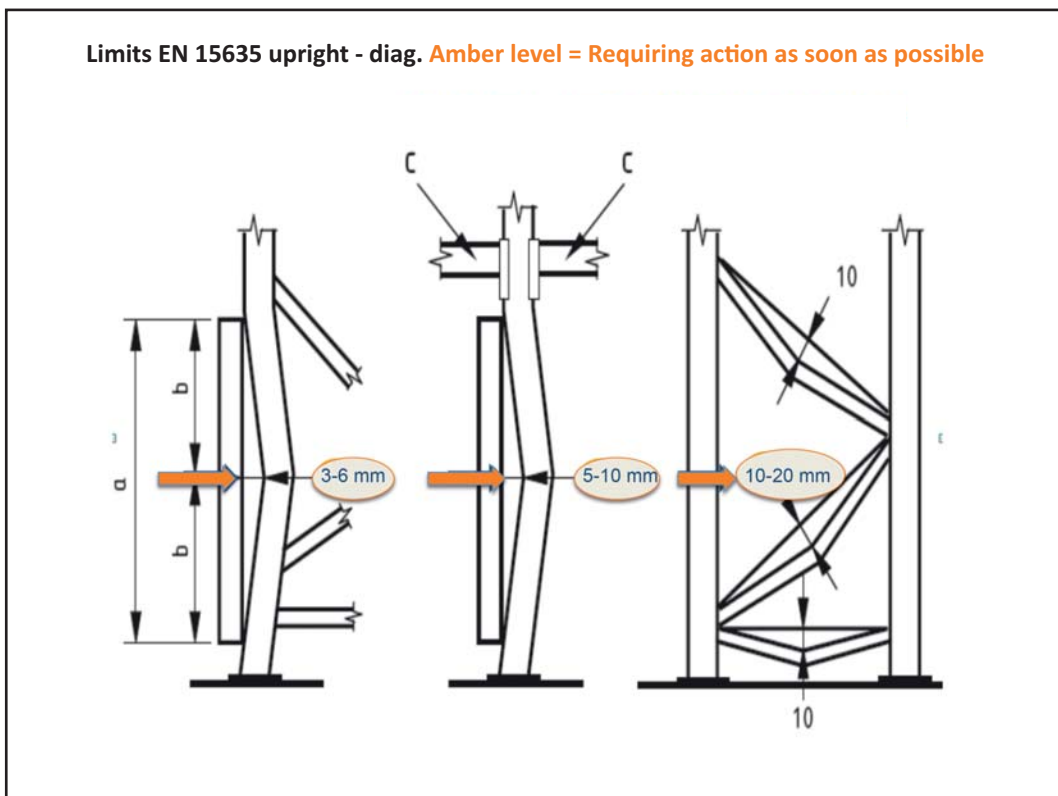
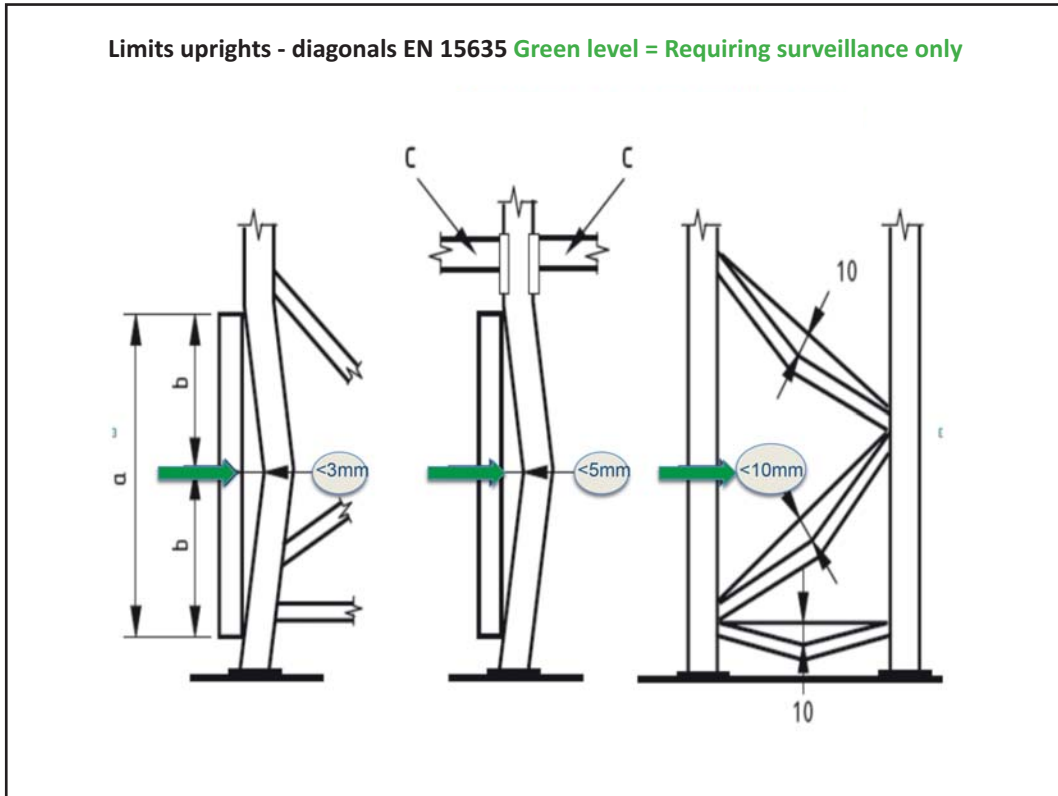

Racking Safety

Limits uprights - diagonals EN 15635 **Red Warning = Immediate action required**

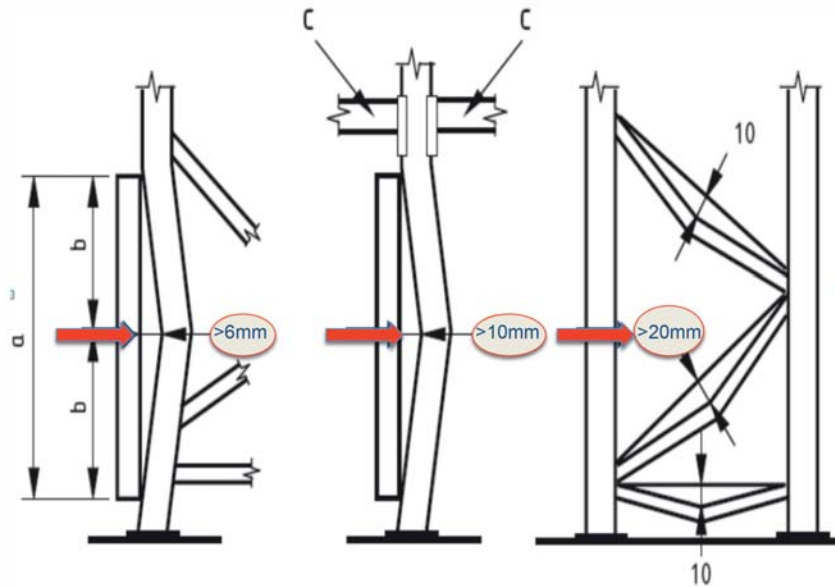

Deflection limit EN15635 - Crossbeams

Maximum Deflection = Length/200

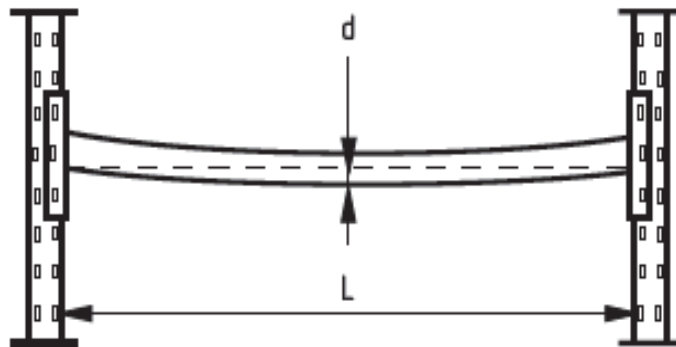



June 2017.

A truck driver received fatal injuries when he attempted to gain access to the flat body of the truck (to secure the load).

It appears that from the ground, he placed his left foot on one of the tyres and took hold of a handle which was designed into one of the precast products. As he tried to pull himself up, the pulling force caused the precast element to be pulled down on top of the driver, who despite wearing a helmet suffered face and head injuries as he fell backwards.



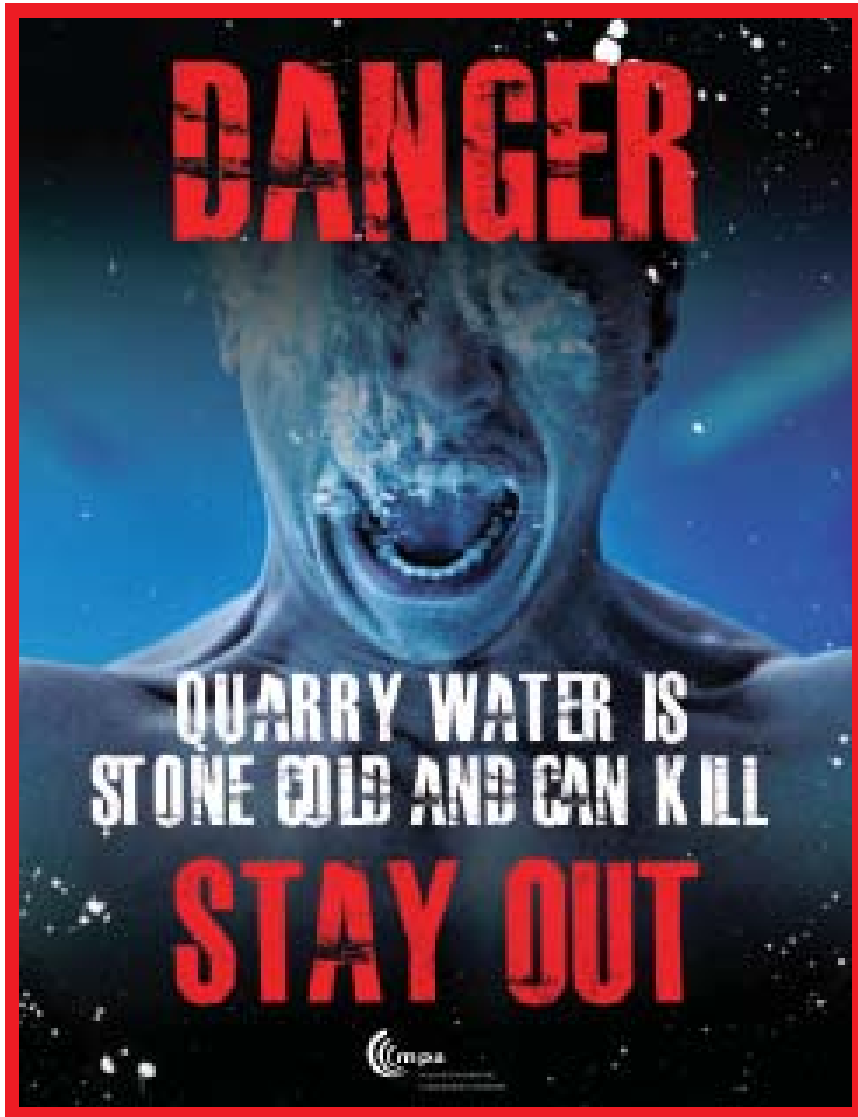

Requirement 18 on page 82 refers to the issue of preventing trespass into sites in order to use our water areas for recreational purposes.



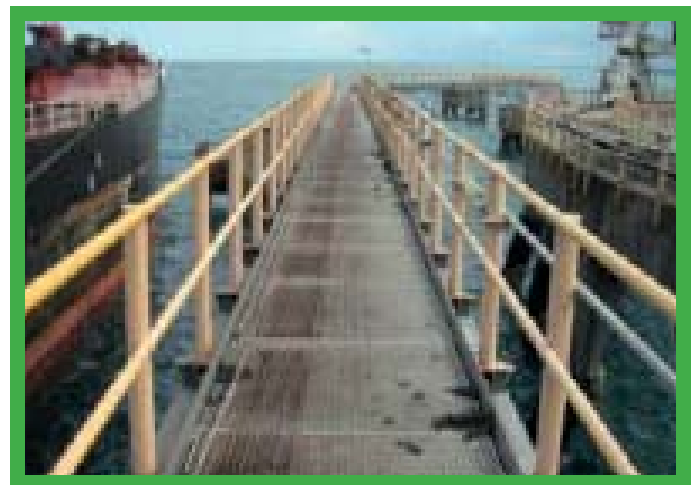

Fatal accident (not a CRH site): A 27-year old deck hand with 4 years and 8 months of experience drowned at a dredge operation. He was working on a dredge that had a barge attached to it. The victim stepped on to the barge, slipped on ice and fell into the water.



Introduction

In terms of the risk management of work in confined spaces, it was agreed that 2 key risk management approaches would be taken:

1. The definition of confined space, will be taken in the context of elimination of hazards, that is:
 - Hazard of engulfment - work in silos, work in excavations.
 - Hazard of fire/explosion - contact with underground services or overhead power lines.
 - Hazard of oxygen depletion.
 - Hazard of exposure to toxic gases.
 - Hazards of falling objects.

Some confined spaces are fairly easy to identify, eg enclosures with limited openings such as:

- Storage tanks
- Silos
- Reaction vessels
- enclosed drains
- Sewers

Others may be less obvious, but can be equally dangerous, for example:

- Open-topped chambers
- Combustion chambers in furnaces etc.
- Ductwork;
- Unventilated or poorly ventilated rooms

2. All risk assessments must be reviewed to ensure the following issues have been included:
 - The need to eliminate work in confined spaces, through design and procedure.
 - Risk assessment and safe systems of work for such tasks to cover:
 - Risk of engulfment.
 - Risk of fire / explosion.
 - Risk of oxygen depletion.
 - Risk of exposure to toxic gases.
 - Risk of falling objects.
 - Formal planning and resourcing of such work.
 - **NO** lone working.



Requirements for Rule No.13

1. All locations must have a documented confined space entry policy and supporting rules for each confined space identified on site. All confined space entry points shall be identified and properly labelled as such.
2. Employees must seek prior authorisation to enter a confined space and documented authorisation procedures must form part of each location's confined space entry policy.
3. All confined space permits/authorisations must include a rescue plan (see incident on page 99). The rescue procedure outlined should be tested with emergency drills at least twice per year.
4. Shoring or appropriately designed sloping must be provided for all excavations over 1.5m (5 feet) in depth (where national legislation requires shoring at depths less than 1.5 metres, then that national requirement must be met).
5. All employees, who may be involved in confined space work, must be trained in the confined space entry rules including rescue / emergency procedures. Annual emergency drills should be carried out where specified in the site risk assessment.
6. All confined spaces identified by the site level risk assessment must be identified by means of signs (see photos on pages 96 and 97). If as part of the confined space risk assessment, areas which are identified as confined spaces, but are not intended to be entered should be sealed off or have entry (into that space) restricted.





October 31st 2017:

Contractor involving in cleaning entered a duct, when the air slide between the duct and the hopper overhead was opened in error - he was engulfed and fatally injured.



Fatal Accident 2007:

The deceased was attempting to clear a raw meal silo blockage, by using a makeshift "bridge" to enter the silo. While working from the bridge, material from overhead came loose, struck the bridge causing the victim to fall. He suffocated within the material.

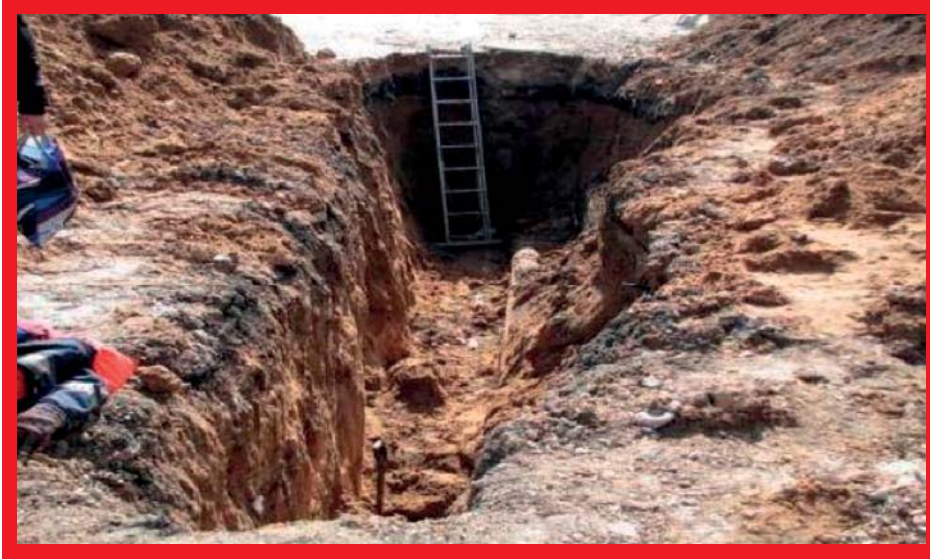

*Fatal Accident 2009:
Trench (2.1m) collapsed no shoring/support.*



*Incident 2011:
A specialist contractor was engaged to carry out a general inspection of a rail wagon used for storing waste solvent. During this process the worker showed signs of being overcome by fumes - the person observing the work from outside entered the tank to assist and also experienced difficulties - a second observer activated the rescue plan and both men were safely removed and treated.*

Introduction

Notes:

- Lone working refers to a situation where a person is the only person on site at an operation i.e there is no one else on site.
- Remote working relates to a situation where a person is not the only person on site but he is working remote from others e.g drilling personnel.

Lone working is not permitted at company operational sites unless a risk assessment has been carried out by the company safety personnel or other qualified person.

A risk assessment must be carried out for all those working remotely and that risk assessment must assess:

1. The health of the person involved - has the person any medical condition which warrants additional monitoring measures when they are working remotely.
2. Communication - that this person has a means of communication e.g a mobile phone available to him so he can contact other persons on site.
3. Has the person working alone or remotely received detailed work instructions which tell him/her what they can and cannot do.

Example: A worker is required to open an operational site at 6 am and to start certain machinery. A procedure must be put in place to make sure that points 1 to 3 above are covered and in this case the worker must be issued with and trained on a procedure which clearly states what he can and cannot do. For example in this case, the procedure could state that if a fault develops in the machinery (which he has started) then he cannot attempt to rectify that fault unless there is a second person in attendance.



Man Down Unit.



On site Receptor (top box).

Requirements for Rule 14

1. All lone and remote working must be identified and a formal risk assessment completed for such work.
2. The need for additional training for those working in lone or remote work must be considered in the risk assessment for that work.
3. All 2 way analogue radios should be considered for replacement with digital radio systems (with integrated man-down features).



Man Down System.

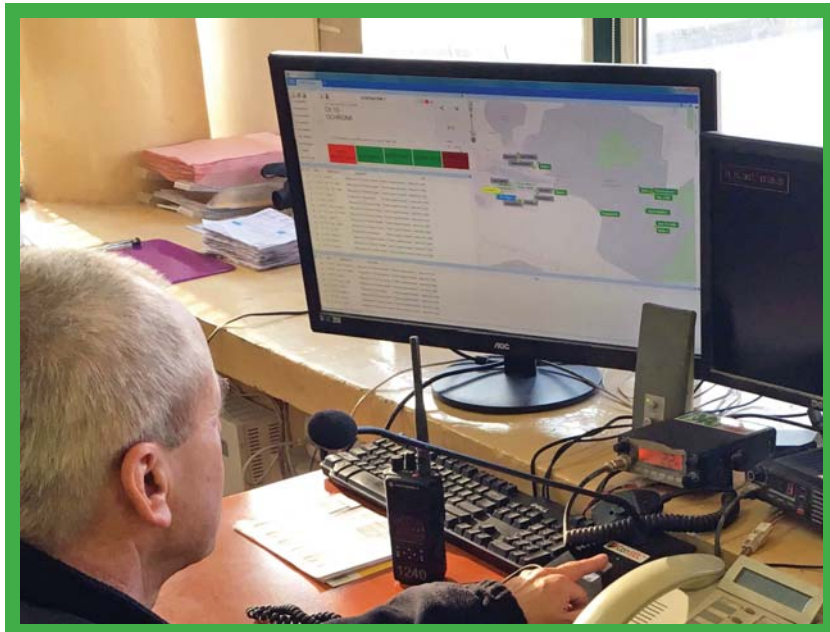

On site monitoring of lone/remote worker.

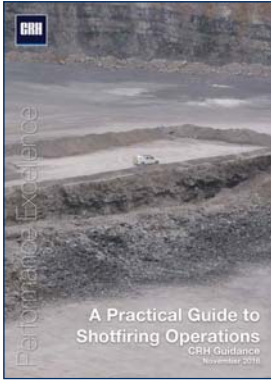

Introduction

There have been a number of flyrock incidents in group companies, any of which could have resulted in fatal injuries to employees, contractors and indeed members of the public.

In order to eliminate such dangerous occurrences, the following systems are required for each drilling and blasting operation.

Drilling

- Each driller must have completed a training course, which focuses on basic shotfiring procedures i.e burden and spacing considerations, causes of flyrock, dangers of clay in quarry faces, dangers of falling from the face, dangers from angled holes.
- Each drill rig and associated compressor must undergo a full detailed inspection at least once per year.
- Each compressor system must be fitted with a device to restrain the compressed air line in the event of it coming loose from the compressor.

Blasting

- All those involved in blasting operations must receive specialised training in the use of explosives.
- Key parameters such as burden, spacing, amount of explosive, hole depth and angle must be recorded for each blast.
- A risk assessment must be completed for each blast and a " Danger Zone " must be determined and recorded in writing for each blast.

A guidance document entitled " A practical guide to shotfiring operations" has been designed to assist operations in implementing these requirements.

Requirements for Rule No.15

1. Companies should now arrange to have in place system for the formal training of all those involved in drilling and blasting. Systems to record key data for both drilling and blasting should now be introduced.
2. Each operation, where blasting takes place, must have a documented site specific "safe blast policy" and implementing rules.
3. Operating records of all blasts must be maintained.



See also Rule No.12



Group Incident - Case Study 2001:

Fly-rock from the blast travelled some 300 metres causing extensive damage to quarry equipment and a nearby factory (fortunately no injuries).

Incident - Case Study 2007:

Fly-rock from the blast travelled some 100 metres onto a nearby public road and struck a school bus and another vehicle injuring 4 people (3 of whom were schoolchildren).

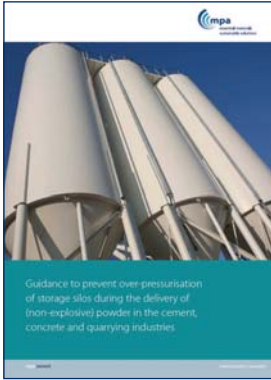

Introduction

This is a broad based rule covering the required safety management principles around process safety. Rule 16 deals with the following:

1. Prevention of contact with hot material, gases and surfaces.
2. Prevention of Fire & Explosions.
 - a. Including the prevention of overpressurisation in vessels.
3. Process: Change management.
4. Storage, handling and process use of hazardous substances.

1. Prevention of contact with hot material

A risk assessment of the overall process must identify and record each potential discharge point and the define the:

- Operational controls
- Fail safes
- Work practices

to be applied to prevent discharges and protect personnel from exposure to hot material, gases and surfaces.

As a minimum the risk assessment must consider, where relevant, the following facilities and processes including all subcomponents within that process:

Cement Manufacturing:

- Raw mill systems
- Pre-heaters and pre-calciners
- AFR feeding systems (kiln feeding)
- Rotary kiln – kiln lines
- Clinker cooler and clinker handling systems
- Cement mills.
- All activities involving the removal of:
 - cyclone blockages
 - coatings
 - dust settlings
 - cooler blockages
- Removal and handling of samples of hot meal and bypass dust
- Planned kiln start up and shut down
- Any maintenance or inspection activity which involves removing equipment that may expose people to hot material or gases, such as kiln inlet probes, cooler cameras, air blasters etc.





Heat Resistant Suits.





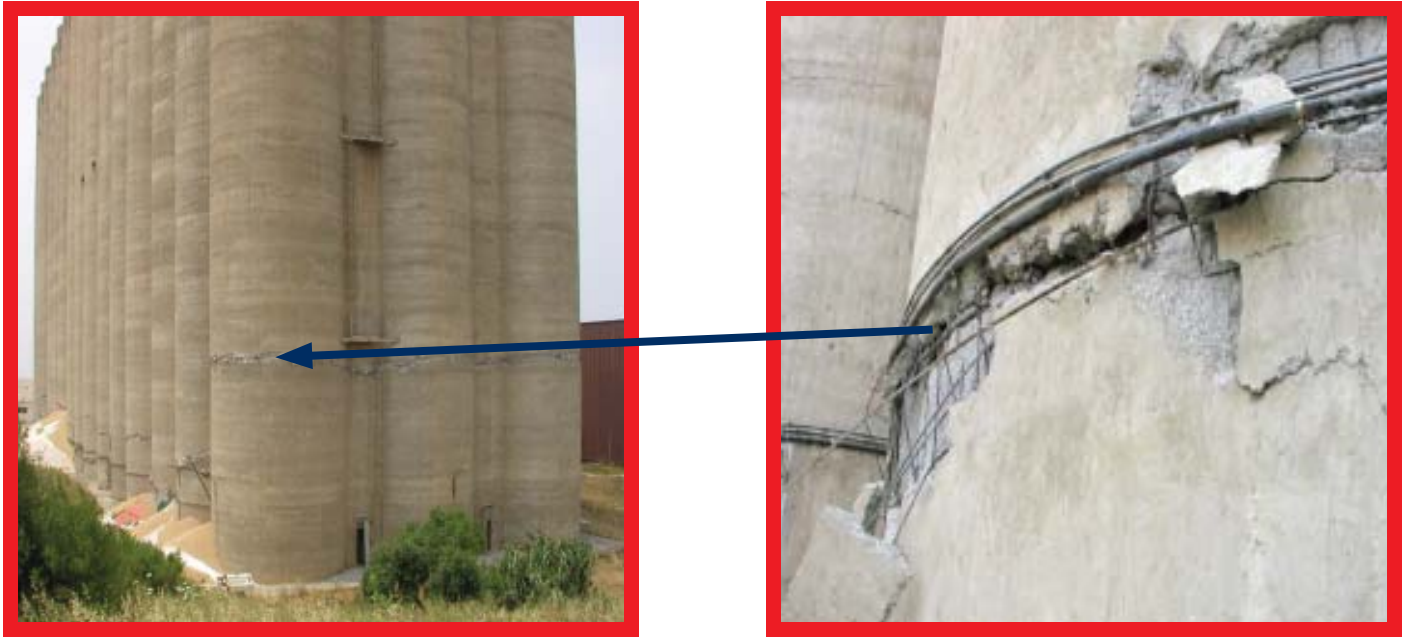

The **VDZ Guidance Document** (see page 104) must be used as a reference document when conducting and reviewing risk assessments relating to work in preheater towers and other areas where contact with hot material or dust is a risk. This guidance document covers the issue:

- Blockage detection / clearing blockages.
- PPE selection.
- Emergency procedures / design of escape routes etc.
- Sampling.

Ancillary Services:

- Gas bypass and dust handling systems.
- Hot gas generating, extraction and exhaust systems.
- Boiler and/or heat exchangers of heat recovery systems.
- Coal mills and other fuel preparations systems.

Bitumen: Handling & Use

- Transfer pipes and valves.
- Discharge pipes and valves.

Lime Manufacture:

- Heating
- Cooling
- Hydration

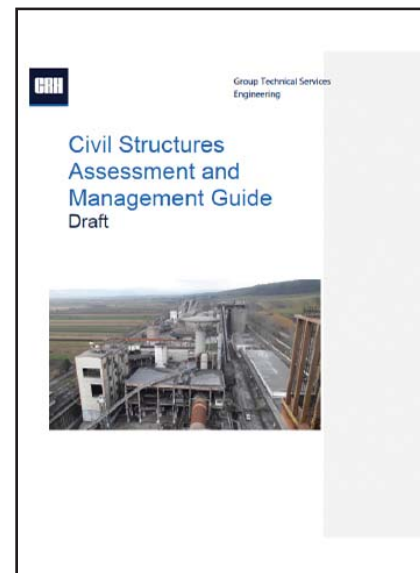

To be issued in 2018

2. Prevention of Fires & Explosions

- Each operation will be required to develop a dedicated risk assessment which identifies potential areas of fire and explosive risk within their operations.
- The risk assessment will have to cover:
 - Identification of situations where the development of an explosive atmosphere is possible and the risk control measures required.
 - Control measures in place to prevent fire arising out of maintenance activities:
 - Oxy-Fuel and Electric arc welding.
 - An assessment of current fire detection and fire suppression systems.
 - An assessment of current extraction and ventilation system to prevent the build-up of an explosive atmosphere.
 - Assessment of current measures in terms of fighting a fire including personal protective clothing and equipment.

Silo pressurisation: There have been a number of incidents where overpressurisation in silos has resulted in parts such as filters being blown some distance from the plant. Blocked filters and damaged or under-rated relief valves have been some of the causes of such accidents. The MPA (Mineral Producers Association) guidance note in relation to the prevention of overpressurisation. **“Guidance to prevent overpressurisation of storage silos during the delivery of (non explosive) powder in the cement, concrete and quarrying industries”** provides specific information to assist in the development of these risk assessments. As a minimum each silo, which is capable of being pressurised, must be fitted with:

- High Level Alarm.
- Pressure Relief Valve.
- A means to ensure the level of available capacity within the silo can be determined.
- Pinch valve on filling pipe to prevent back flow of material.
- The use of chains to secure the filter (as a final backup in the event of failure of primary measures) should also be considered.

3. Process: Change Management

A system must be in place at each operation to ensure that changes or modifications to the manufacturing process and ancillary services which contain, process or transfer materials at high temperature must be subjected to a risk assessment and risk controls defined and communicated prior to the change or modification being performed.



Silo Filter.

Pressure Relief Valve.



*Incident - Near Miss 2012:
Filter blown onto nearby area*



*Last line of defence:
Filter chained to silo structure.*



Whipcheck Safety Cable.

4. Storage, handling and process use of hazardous substances

The requirements here focus on hazardous substances in use at our operations, ranging from various types of alternative fuels, some admixtures, bitumen and process gases.

For each type of hazardous material, a dedicated risk assessment must be developed covering the following:

- Storage safety requirements:
 - Location.
 - Storage area infrastructure/design.
 - Condition of tanks, drums etc / Required inspection regimes.
 - Stock control.
 - Site security.
 - Ventilation and extraction requirements.
 - Earthing.
- Handling
 - Material handling requirements.
 - Occupational Health risks.
 - PPE requirements.
 - Training and competency.
- Use
 - Risk of Fire:
 - Risk of incorrect fire fighting medium being used.
 - Risk of explosion.
 - Required process parameters and risk when those parameters change.

A CRH safety guidance note relating to the safe handling, storage and use of alternative fuels is available.

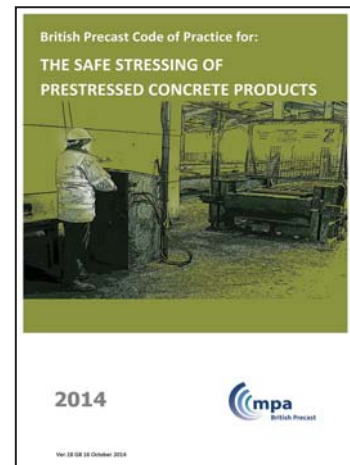
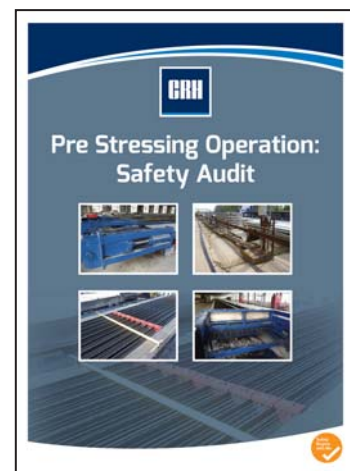

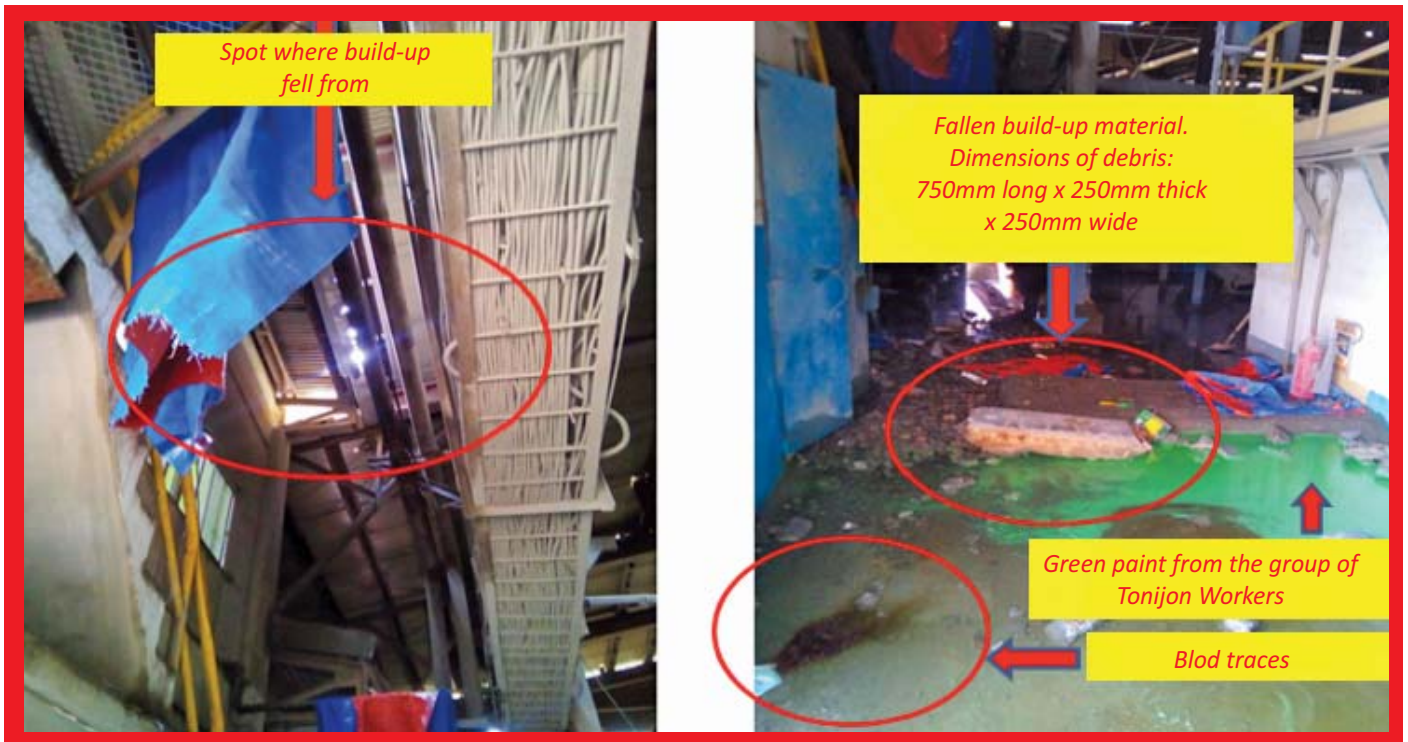

September 2016:

2 contract workers were taking shelter during a storm when a portion of the roof's center gutter, about 6 meters above their location, partially collapsed and released hardened cement material deposits to fall. A large piece of debris, approximately 750mm long x 250mm thick x 250mm wide struck the deceased on the back of the head under his helmet, knocking him down unconscious. He later died of his injuries.

Requirements for Rule No.16

1. A risk assessment of the overall process must identify and record each potential discharge point and the define the
 - Operational controls
 - Fail safe mechanisms
 - Work practices
 to be applied to prevent discharges and protect personnel from exposure to hot material, gases and surfaces.
2. The VDZ guidance document (see page 110) must be used as a reference document when conducting and reviewing risk assessments relating to work in preheater towers and other areas where contact with hot material or dust is a risk. This guidance document covers the issue.
3. Each operation will be required to develop a dedicated risk assessment which identifies potential areas of fire and explosive risk within their operations.
4. A system must be in place at each operation to ensure that changes or modifications to the manufacturing process and ancillary services which contain, process or transfer materials at high temperature must be subjected to a risk assessment and risk controls defined and communicated prior to the change or modification being performed.
5. For each type of hazardous material, a dedicated risk assessment must be developed covering the issues of storage, handling and use.

Requirements for Rule 12 (cont.)

6. The MPA (Mineral Producers Association) guidance note in relation to the prevention of over-pressurisation. ***“Guidance to prevent over-pressurisation of storage silos during the delivery of powder in the Cement, Concrete and Quarrying Industries”*** must be used in the development of relevant risk assessments.
7. All operations where prestressing of cables is an element of manufacture must:
 - Fulfil the requirements of the MPA (UK Minerals Producers Association) guidance note “ The safe stressing of prestressed concrete products “. In particular, the use of pre-start check procedures (before pre-stressing occurs) must be in place.
 - Complete on an annual basis, the BPA (British Precast Association) “ Audit checklist for pre stressing operations”.
8. Cement tanker discharge pipes have the potential to disconnect from the plant if the retaining clasp fails. With no secondary catchment device to hold the pipe, it can whip due to the pressure in the pipe, with the potential to cause serious injury to anyone in the vicinity. To protect any this risk, a whipcheck safety cable (see photo on page 109) must be in place at the discharge point(s).
9. Occupational Health:
 - From January 2018, all operations must report on the following 2 Occupational Health KPI’S:
 - Occupational illness frequency rate.
 - % of employees working on sites where the recommendations from the CSI Health Management Handbook, relating to Noise and Dust, have been implemented.
 - Where dust masks are issued to personnel, as a control measure to reduce exposure to dust, then each such employee should have an individual face fitting for that dust mask, to ensure a correctly fitting and suitable dust mask is made available.
10. Structural Safety: Each operating company must have in place an overall risk assessment which covers the issue of structural safety at it’s operations. This opco level risk assessment should cover:
 - Reference to (and the presence of) an internal database which includes all structural safety issues raised previously from internal inspections and external inspections e.g insurance company surveys.
 - This internal database must detail remedial measures in place for each structural safety issue raised.
 - An overall approach to an ongoing program and schedule of inspections of structures within the opco.
 - CRH Group Technical Services have produced a guidance note on Structural Safety.
11. Housekeeping: all sites must have procedures in place to demonstrate a systematic approach to housekeeping. This overall program should cover:
 - Standard required/expected in terms of housekeeping at the site.
 - A fugitive dust control assessment and corrective action program.
 - Clear area (of the operation) line management responsibility for housekeeping.

